

DOCUMENT RESUME

ED 047 810

PS 004 452

AUTHOR Sale, June  
TITLE Programs for Infants and Young Children. Part IV:  
Facilities and Equipment.  
INSTITUTION Appalachian Regional Commission, Washington, D.C.  
PUB DATE Oct 70  
NOTE 72p.  
EDRS PRICE MF-\$0.65 HC-\$3.29  
DESCRIPTORS Acoustical Environment, \*Child Development Centers,  
Community Involvement, Day Care Services,  
\*Equipment, Facility Requirements, Infants,  
Information Sources, \*Interior Design, Lighting,  
Parents, \*Physical Facilities, Playgrounds,  
Plumbing, Preschool Children, \*Space Utilization,  
Storage, Ventilation

ABSTRACT

This manual is designed to facilitate planning for day care center facilities. Goals and principles of day care are discussed in relation to programs for infants, toddlers, and preschoolers with special attention to staff, parents, and community. Suggestions are presented for indoor and outdoor planning for such topics as equipment, supplies, ventilation, acoustics, lighting, temperature control, storage, and numerous other areas of concern. Provided in the manual is a partial list of resources for the purchase of equipment and supplies. The manual offers various floor and plot plans and practical patterns for the construction of equipment, such as shelves, cupboards, book and coat racks. A bibliography is included to provide further sources of information.  
(AJ)

ED047810

U. S. DEPARTMENT OF HEALTH, EDUCATION & WELFARE  
OFFICE OF EDUCATION

THIS DOCUMENT HAS BEEN REPRODUCED EXACTLY AS RECEIVED FROM THE  
PERSON OR ORGANIZATION ORIGINATING IT. POINTS OF VIEW OR OPINIONS  
STATED DO NOT NECESSARILY REPRESENT OFFICIAL OFFICE OF EDUCATION  
POSITION OR POLICY.

## **Programs for Infants and Young Children**

### **Part IV: Facilities and Equipment**

**By June Sale For  
The Child Development Staff**

**APPALACHIAN REGIONAL COMMISSION  
1666 Connecticut Avenue, N. W.  
Washington, D. C. 20235**

**OCTOBER 1970**

5004452

### ACKNOWLEDGMENTS

*We wish to thank Docia Zavitkowsky,  
Director of Santa Monica Children's  
Centers for her helpful advice and  
Dorothy M. Patton for the endless  
hours of typing and planning the  
layout for this Manual.*

**TABLE OF CONTENTS**

|   | Page               |
|---|--------------------|
| <b><u>PLANNING A CHILD DEVELOPMENT PROGRAM</u></b> -----      | <b>1 - 16</b>      |
| Goals of Planning-----  | 1 - 4              |
| General Principles in Planning----                            | 5 - 9              |
| Infants' Programs-----  | 10                 |
| Toddlers' Programs-----                                       | 11- 12             |
| Preschoolers' Programs-----                                   | 13                 |
| Adults' Programs-----   | 14- 15             |
| Community Involvement-----                                    | 16                 |
| <br><b><u>INDOOR AND OUTDOOR PLANNING</u></b> -----           | <br><b>17 - 46</b> |
| Interior Design-----  | 17- 29             |
| a) Flooring -   | 17-18              |
| b) Doors-----   | 19-20              |
| c) Windows &<br>Ventilation                                   | -21                |
| d) Storage---   | 22-24              |
| e) Lighting<br>and<br>Electrical<br>Fixtures -                | 25                 |
| f) Wall cover<br>and<br>Display Space                         | 26                 |
| g) Bathrooms--  | 27                 |
| h) Kitchens---  | 28-29              |
| <br>Outdoor Design-----                                       | <br>30- 46         |
| a) Safety ----  | 37                 |
| b) Ground<br>Cover-----                                       | 38-39              |
| c) Temperature<br>Control-                                    | 40                 |
| d) Acoustics--  | 41                 |
| e) Lighting,<br>Plumbing<br>and<br>Electrical<br>Outlets----- | 41                 |
| f) Storage---   | 42-43              |
| g) An Outdoor<br>Checklist-                                   | 44-46              |

|   | Pages     |
|---|-----------|
| <u>EQUIPMENT AND SUPPLIES</u> -----   | 47-56     |
| Indoor-----   | 48-54     |
| Outdoor-----  | 55-56     |
| <br><u>PARTIAL LIST OF RESOURCES FOR THE PURCHASE OF EQUIP-<br/>MENT AND SUPPLIES</u> ----- | <br>57    |
| <br><u>PATTERNS AND PLANS</u> -----   | <br>58-66 |
| Floor and Plot Plans-----   | 58-60     |
| Patterns for<br>Construction of Equipment-----  | 61-66     |
| Toy Shelves -<br>Top Cupboards-----   | 61        |
| Bookrack and Toyshelves--   | 62        |
| Book display-----   | 63        |
| Cubbies-----  | 64        |
| Movable Coat Rack-----  | 65        |
| Toy and Storage Cupboard-   | 66        |
| <br><u>BIBLIOGRAPHY</u> -----   | <br>67-68 |

GOALS  
of  
PLANNING

Planning a child development program should be a challenge! Planning the facilities and equipment necessary for the program should be exciting.

Implementing these will be difficult, expensive and rewarding. The development of a quality program takes time and patience. This manual will present some of the problems, solutions, ideas and dreams for facilities and equipment for a child development program that may be applied in part to your local project. It is a beginning that will have to be extended and enriched, using local know-how and resources. Let us begin by asking some questions.

- 1) To which families are you directing your program and for what purposes?
- 2) What are the goals for your child development program? What is the philosophy or method you plan to use to implement the goals?
- 3) What age child are you planning to serve?
- 4) Where will you locate your program? In a center? In a group home? In the child's home?
- 5) How will parents be involved? In the center? In their home?
- 6) If a center program -- what other services will be provided at the center? Counseling? Medical? Education? Homemaking classes (sewing, nutrition, cooking, weight watchers, etc.)?
- 7) How many hours will be spent with the child? With the parents?
- 8) What will the staff/child ratio be?
- 9) What are the licensing requirements of your area?

Answer these questions and then we can begin to plan for an environment that will provide the kind of space and equipment necessary to achieve the goals of the program.

After determining the philosophy and scope of the program, an environment may be designed including the use of space, equipment and furnishings. All have a common denominator -- the well being of the infant and child, but some have different objectives or programs to meet different needs such as ...

If ...

a program is projected that will serve infants in a day-care program for working mothers, the environment may include plans for a kitchen, staff room, nursery and small grassy outdoor area.

If ...

a program is projected for 3-6 year olds in a morning Montessori-oriented program, the environment will have to provide large rooms for the children, and outdoor area, with bathroom facilities for young children and special equipment to be ordered, in addition to staff requirements.

If ...

a program is projected for infants, toddlers and preschoolers based on a developmental learning-theory philosophy, with an experimental design that includes observation, then the space requirement might include separate rooms for each age group, observation rooms, staff rooms for testing, different types of bathroom facilities for each age group, a variety of outdoor plans, etc.

The following charts may be helpful in determining some of the space needs of the program you plan.

(See Pages 3 and 4)

S P A C E F O R C H I L D R E N

|            | Classroom or Nursery | Outdoor | Bathrooms | Isolation Room & Medical Exam's. | Kitchen | Observation Room | Testing Room |
|------------|----------------------|---------|-----------|----------------------------------|---------|------------------|--------------|
| Number of: |                      |         |           |                                  |         |                  |              |
| Infants    |                      |         |           |                                  |         |                  |              |
| Toddlers   |                      |         |           |                                  |         |                  |              |
| Preschool  |                      |         |           |                                  |         |                  |              |

S P A C E F O R S T A F F

|                | Office Space | Classroom Storage | Library | Interview Rooms | Other Storage |
|----------------|--------------|-------------------|---------|-----------------|---------------|
| Number of:     |              |                   |         |                 |               |
| Admin.         |              |                   |         |                 |               |
| Teachers       |              |                   |         |                 |               |
| Aides          |              |                   |         |                 |               |
| Nurses         |              |                   |         |                 |               |
| Med. Personnel |              |                   |         |                 |               |
| Social Workers |              |                   |         |                 |               |
| Janitors       |              |                   |         |                 |               |
| Cooks          |              |                   |         |                 |               |
| Other          |              |                   |         |                 |               |

S P A C E F O R P A R E N T S A N D C O M M U N I T Y

|                         | Parent Lounge | Library | Parent Education Room | Community Meeting Room |
|-------------------------|---------------|---------|-----------------------|------------------------|
| No. of Parents          |               |         |                       |                        |
| No. of Siblings         |               |         |                       |                        |
| 5 - 11                  |               |         |                       |                        |
| 12 - 16                 |               |         |                       |                        |
| No. of Community People |               |         |                       |                        |



DATE REQUIREMENTS

|                           | ALA. | GEO. | KY. | MD. | MISS. | N.Y. | N.C. | OHIO | PA. | S.C. | TENN. | VA. | WEST VA. |
|---------------------------|------|------|-----|-----|-------|------|------|------|-----|------|-------|-----|----------|
| ITS                       |      |      |     |     |       |      |      |      |     |      |       |     |          |
| No. Exits                 |      |      |     |     |       |      |      |      |     |      |       |     |          |
| Width-Exits               |      |      |     |     |       |      |      |      |     |      |       |     |          |
| <b>MULTI-CHILD RATIO:</b> |      |      |     |     |       |      |      |      |     |      |       |     |          |
| Infants                   |      |      |     |     |       |      |      |      |     |      |       |     |          |
| 2 year olds               |      |      |     |     |       |      |      |      |     |      |       |     |          |
| 3 year olds               |      |      |     |     |       |      |      |      |     |      |       |     |          |
| 4 year olds               |      |      |     |     |       |      |      |      |     |      |       |     |          |
| 5 year olds               |      |      |     |     |       |      |      |      |     |      |       |     |          |
| <b>LUMBING</b>            |      |      |     |     |       |      |      |      |     |      |       |     |          |
| Persons/MC & Lav.         |      |      |     |     |       |      |      |      |     |      |       |     |          |
| 1 - 15                    |      |      |     |     |       |      |      |      |     |      |       |     |          |
| 16 - 35                   |      |      |     |     |       |      |      |      |     |      |       |     |          |
| 36 - 55                   |      |      |     |     |       |      |      |      |     |      |       |     |          |
| 56 - 80                   |      |      |     |     |       |      |      |      |     |      |       |     |          |
| <b>DRINKING FOUNTAINS</b> |      |      |     |     |       |      |      |      |     |      |       |     |          |
| <b>FIRE REGULATIONS</b>   |      |      |     |     |       |      |      |      |     |      |       |     |          |
| Inspections               |      |      |     |     |       |      |      |      |     |      |       |     |          |
| <b>VENTILATION</b>        |      |      |     |     |       |      |      |      |     |      |       |     |          |
| Windows                   |      |      |     |     |       |      |      |      |     |      |       |     |          |
| Other                     |      |      |     |     |       |      |      |      |     |      |       |     |          |
| <b>SPACE</b>              |      |      |     |     |       |      |      |      |     |      |       |     |          |
| Ft. Per Child             |      |      |     |     |       |      |      |      |     |      |       |     |          |
| Inside                    |      |      |     |     |       |      |      |      |     |      |       |     |          |
| Outside                   |      |      |     |     |       |      |      |      |     |      |       |     |          |

**GENERAL PRINCIPLES  
IN PLANNING**

There are some general principles that may be applied in planning programs for young children.

- a quality program is dependent on an adequate ratio of qualified and trained personnel to children.
- All space should be designed for easy supervision of the children

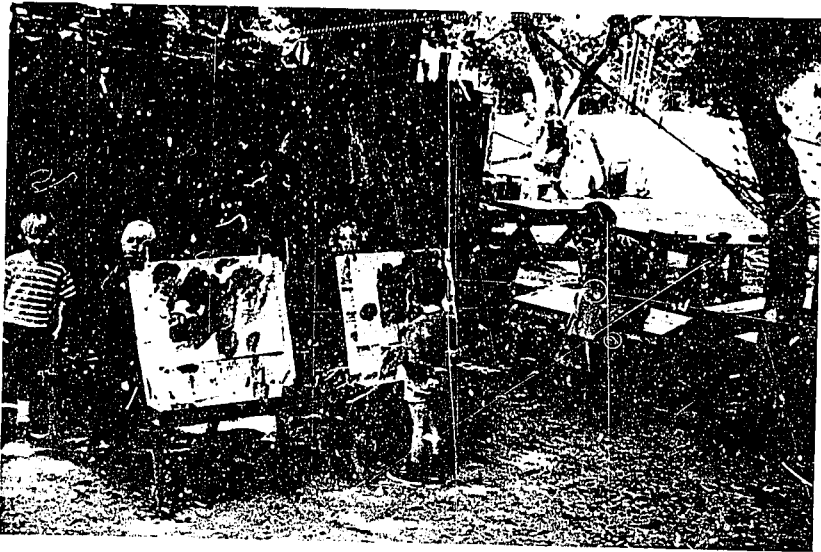

- safety and protection of the children is vital -  
(example) check for covers of all electrical outlets, be sure that windows and doors have safety glass, avoid sharp edged equipment, fences must be constructed to protect children from traffic, etc. Paint should be non-poisonous.

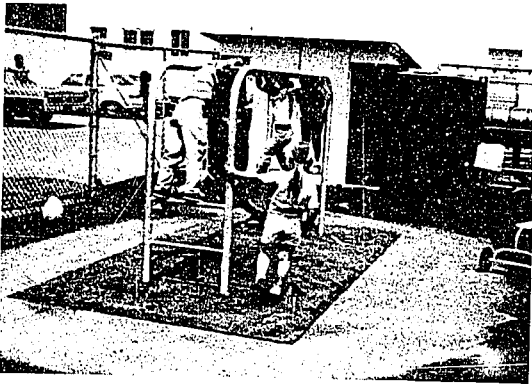

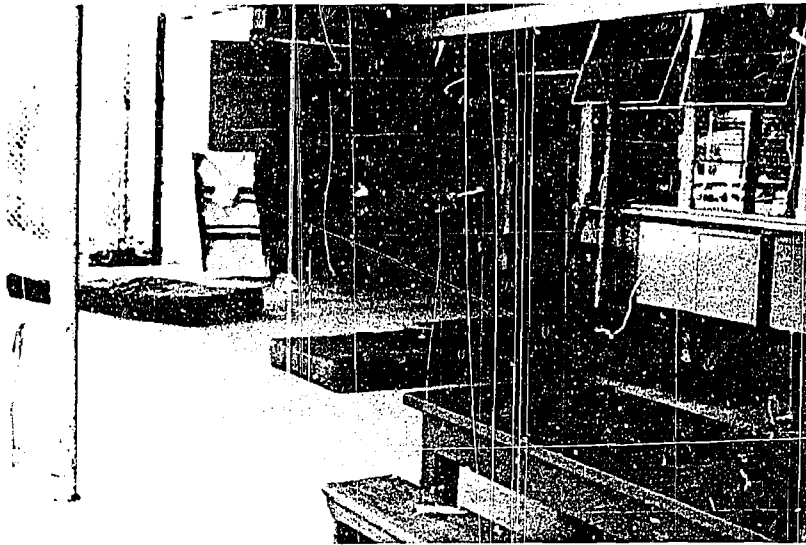

- Simple, uncluttered and functional use of space that provides beauty and an esthetic environment is an important component of a child development program.



- Flexibility and versatility in the planning of space and equipment is desirable. Stationary equipment and furniture tends to lead to limited use and restricts the ability to adjust to changes.

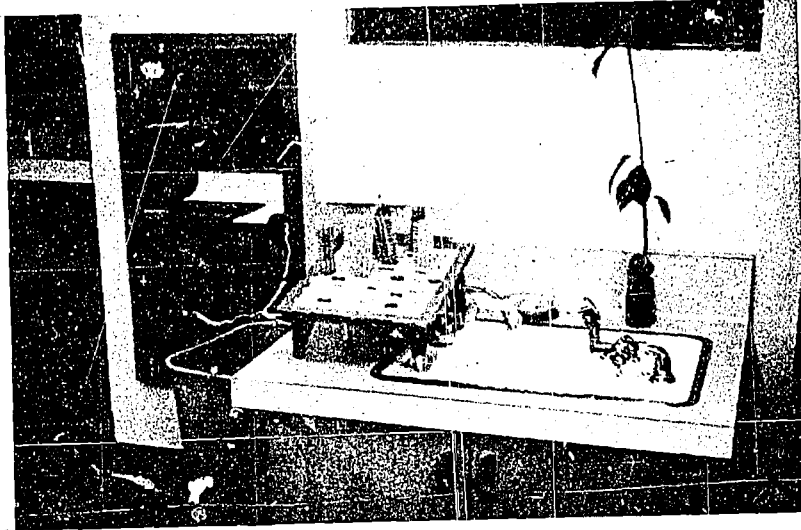

-- water should be easily accessible for:  
staff (washing hands)  
children (drinking and washing hands)

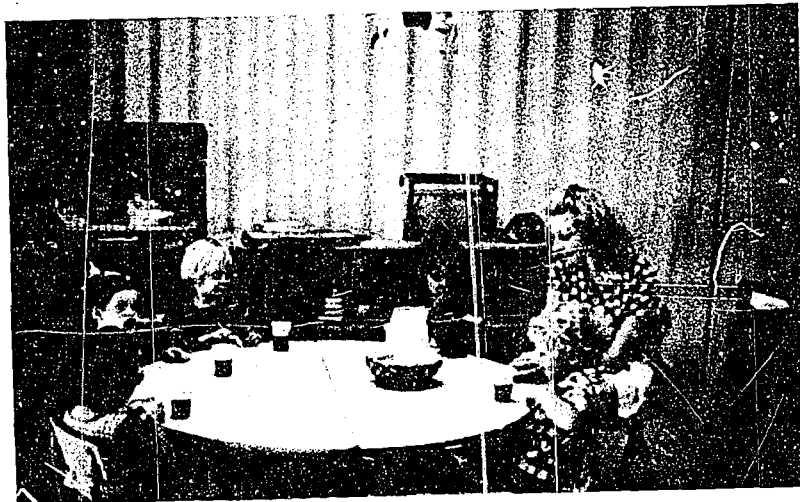

-- walls, ceilings and floors should be sound-  
proof and leak-proof.

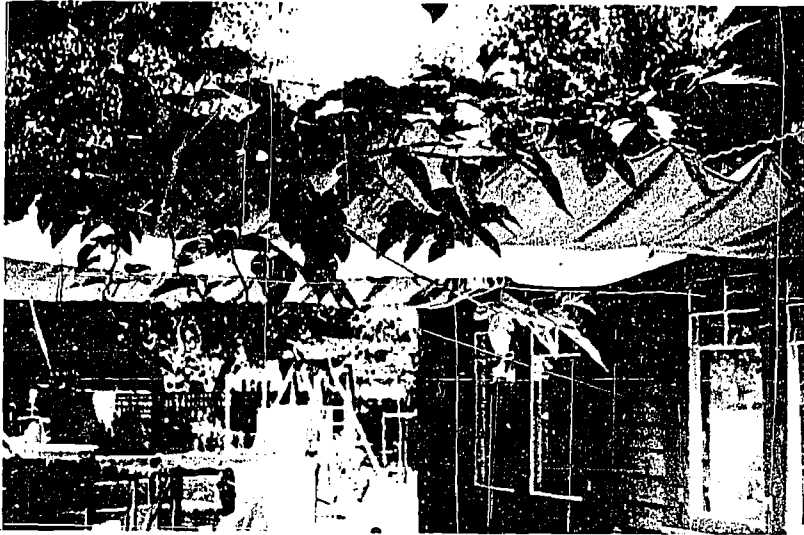

-- Extreme temperature variations should be avoided

It is important to remember that each staff member brings to his job a uniqueness of his own and planning of room arrangements should provide for the widest range and use of individual differences of the adults.

When selecting material and equipment the wide range of interests and abilities of the children must be examined. Equipment should then be purchased that meets the goals of the program and fits some of the following criteria:

- a) The material should be able to be utilized in different ways depending on the development of the children.
- b) The material should encourage imaginative and experimental play.
- c) The material should be fun to use.



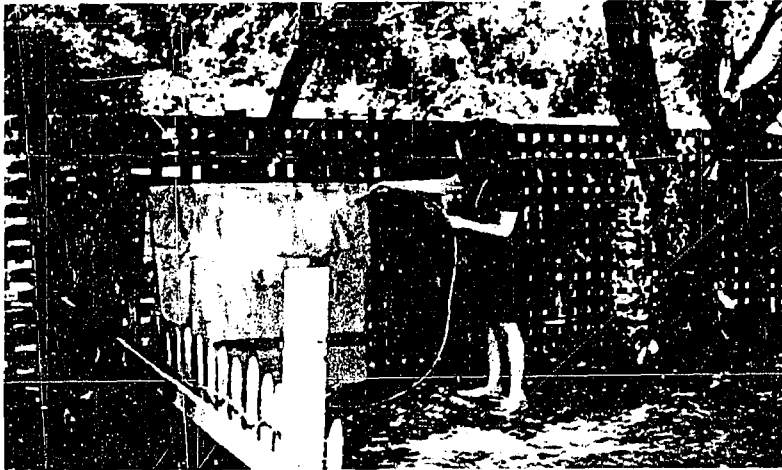

- d) All materials should be "cleanable" or "scrubbable".

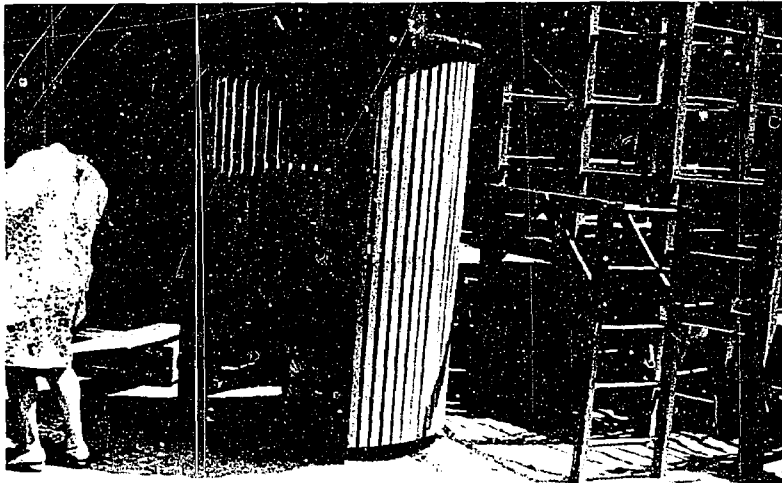

- e) Durable and quality equipment and facilities, while more expensive in the short run, are desirable in terms of safety and usability. "Although the physical facilities portion of your program represents a rather large initial investment, it really is the least expensive. When good, adequate facilities are amortized over a forty-year period of use, they represent only eight to twelve cents of the total dollar spent for the program."<sup>1</sup>

---

<sup>1</sup> (Gibson, Charles Dana, "Preschool Educational Housing", in Housing for Early Childhood Education, (Washington, D.C. -- Association for Childhood Education, International 1968).

There are some generalizations we may make concerning programs for children of different age groups. Of course, we must recognize that there are many overlapping areas, depending on the physical, emotional and social position or stance of individual children at a given time.

**INFANTS' PROGRAMS**  
(6 months to 18 months of age)

A program for infants has to provide a warm, close environment that provides room for the baby to explore and enough closeness to give a feeling of security.

Many physical needs will be met by the staff in caring for infants and so planning should emphasize maximum comfort and minimum physical strain. In considering space for diapering, sleeping, and feeding of infants, the tables, cribs and high chairs should be placed so that there is a minimum of bending and steps to be taken by the infant staff.

Space must also be provided for infants to crawl and explore; a place where infants may listen and watch other children; a place where they may have the experiences of touching, feeling and smelling; a place where an infant may be cuddled and held in a rocking chair.

It is essential that a wash basin be either in the room or very close by in order that the staff be able to wash their hands before feeding each baby, after diapering or helping a child on the potty.

We recommend that a local diaper service be used for soiled infants' clothing. These services must conform to health standards which would be difficult to duplicate or maintain in home or school laundries. The heat of the water and amount of sterilization is inspected by local health authorities in commercial diaper services -- and this helps to prevent the spread of rashes or diseases among the children.

## TODDLERS' PROGRAMS (15 months to 2 1/2 years of age)

The program for toddlers and run-a-bouts differs from the infants' program and the preschool children's in degree, and quantity. The individual needs of the children must be assessed before a meaningful program can be mounted. The toddler still needs a good deal of adult reassurance while he is trying to reach out into the world to master his own body, his relationship with his peers and other adults. He still needs an area that is defined in terms of size, but also needs some challenge that will test his mastery and control of his body, cognitive and language development. The toddler needs space for time alone, and time in small groups; he needs space for resting and sleeping; he needs space for group eating experiences.



The toddler may need to sit on the lap of the teacher at one moment and at the next he may be climbing to the very top of the jungle gym. The environment should provide an opportunity for the children who have just left infancy to go back for moments of comfort, in order to plunge ahead into the greater physical, emotional and cognitive challenges. An adult rocking chair is an important piece of equipment in both the infants' and toddlers' rooms. However, in the toddlers' room, it will be placed among some of the same equipment and supplies that may be found in the older preschool children's rooms. (See illustration, page 13).





The following indoor areas should be provided for both toddlers and preschool children, although the equipment will be used in quite different ways within each program:

- doll or housekeeping area
- music and rhythm area
- books and story area
- block building area
- science area
- arts and crafts area
- manipulative toy area
- listening center

\* \* \*

**PRESCHOOLER'S PROGRAMS**  
(2 1/2 years to 6 years)

The preschooler has developed some degree of independence, and his need for space and new challenges have grown.

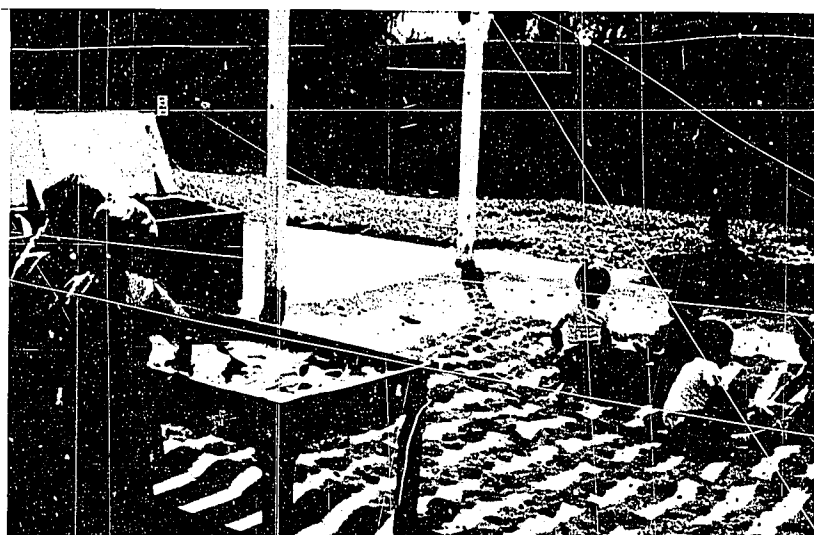

His needs must be individually assessed, but generally we know that he will not need the same ratio of adult-to-child supervision; that he will be interacting with his peers in group activities; that he will be awake more of the day; that he will be eating more independently; that he will be experimenting

and exploring on a more abstract level than the toddler; that he will be using more language and less body to express his needs, desires and feelings. In addition to the indoor areas provided the toddler, the preschooler will be able to participate in cooking experiences, and science experiments. The spaces will be larger as he grows older and larger; the equipment and materials will be more complex as he is able to think and act in more advanced ways; the adult support will be more in the background as he is able to handle problems and solutions on his own or with the assistance of his student colleagues.

A list of supplies and equipment (*See Equipment and Supplies*) covers a large age range, and must be put to use to fit the needs of the individual child or groups of children. Example: simple puzzles should be introduced at the beginning of the program and more complicated ones brought in as the children master the original ones. Perhaps 2 or 3 colors of primary paint should be used at the beginning of the program and the secondary colors introduced later and eventually color mixing of primary colors may be utilized.

## ADULTS' PROGRAMS

Adult needs must be carefully considered in the planning of any children's program. If the staff is comfortable and able to carry on their part of the program efficiently, the children's program is likely to reflect the harmony with the environment. The extent of the services offered to the children and their families must be determined before adequate planning can take place. For example:

- are medical examinations going to be provided for the children at the center?
- will social services be provided?
- how many members of the family will be included in services offered? siblings?
- how large will the total staff be? how many will need desk and office space? How many will need telephones?
- to what extent will the center take care of sick children? Will a "sick bay" be provided?

When the extent of the program has been determined, then some thought should go into the planning of the following areas:

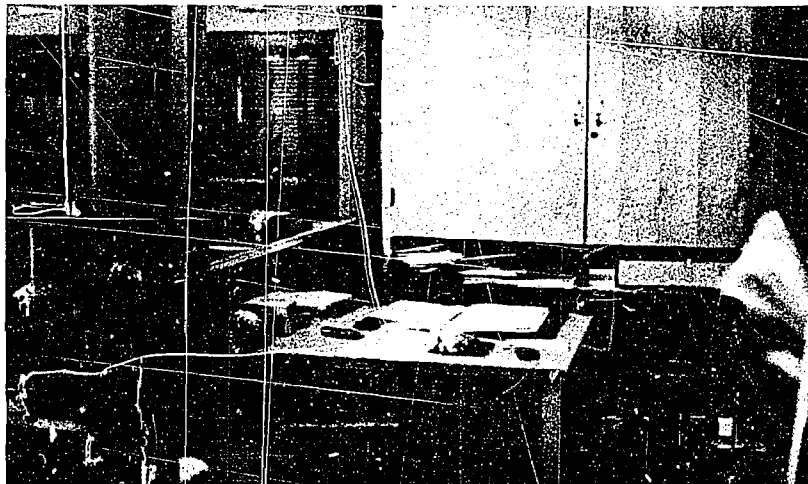

- office space and provision for the collection and storing of records of the children and their families.

- a laundry room that can take care of soiled and other washable clothes and possibly provide parents with an automatic washer and dryer that is unavailable in any other place for them.
- storage of adult supplies and equipment mentioned in the section on Interior Design



- library for staff and parents
- interview rooms



- parent lounge
- staff lounge

## COMMUNITY INVOLVEMENT

Special note should be made of community involvement in the planning and purchasing of facilities and equipment. Whenever possible the community should be included in the planning because the physical plant and the ideas and concepts that are being developed can become a source of pride among the people for whom the plans are being made. We know that if a community has some feeling of being part of a development, they are more likely to prize, protect and further help its growth. Local people also serve as a source of a great deal of know-how that can help conceptually, as well as materially. Whenever possible, the facility that is developed should make provision for its use by the broader community in which it is located.

For example: one child development center has made several rooms available for after-school tutoring. They alternate the rooms so that the janitor can do the necessary cleaning chores. Another center has planned a program of "nutritional outreach" by utilizing the kitchen as a demonstration center for AFDC mothers. In the afternoons, during a recent fund raising project for a local library, a volunteer committee held a bake-sale on a Sunday afternoon at the center.

Another important area of community involvement lies in the field of code and enforcement. Involving the health, fire, welfare and education community early in any project can save a tremendous amount of time, energy, confusion and frustration. Laws and codes are generally made to protect the children...knowledge of them is essential.

## INTERIOR DESIGN

After the goals and design of the program have been established it then becomes possible to start thinking about how the center will look and feel. What kind of flooring, ceilings, walls should there be? Where should the kitchen be located? Are there enough wash basins? Where will the teachers hang their coats? Should the parents bring the children to one large entrance room or should they come to each child's room with him? There is much to think of when planning the design for the program you wish to implement and often, you may have little choice if you are making use of existing facilities or renovating. However, let us examine some of the possible situations and try and make some generalizations that will be helpful in planning.

Some of the essential ingredients of any interior for children are:

- a) Flooring
- b) Doors
- c) Windows and ventilation
- d) Storage
- e) Lighting and electrical fixtures
- f) Wall cover and display space
- g) Bathrooms
- h) Kitchens

Other important considerations that must be included in any plans for the above items deal with acoustics, safety, color, durability and cleanability.

### a) - Flooring:

The kind of flooring chosen influences the kind of program that is developed. It is desirable to have a variety of flooring materials so that children can have the feeling of different kinds of spaces. Children of all ages will spend a good deal of time on the floor, so that while adults may take this part of the interior for granted, it is an area that is close to the heart and bodies of the children. The flooring should be warm, resilient, easily cleaned and maintained, durable, and parts of it should be soundproofed. There are many new materials that have been developed recently that would fit the criteria necessary for the needs of young children.



washable  
indoor-outdoor  
carpeting

vinyl treated  
linoleums,  
corks, asphalt  
tiles

Other floor  
covers are:

wood floors,  
area rugs,  
terrazo or  
concrete floors,  
and matting

It is important to determine the needs of the children before deciding on the material to be used on the floors:

For example:

The flooring beneath a crib might be washable carpeting in order to help with the sound proofing. However, it would be highly desirable to have a vinyl type covering if the babies are to be bathed in bathinettes or small tubs or fed in another part of the room. Carpeting that is subjected to a lot of water and/or food on it will tend to get soggy and develop a musty smell. It would also be important for an infant who is beginning to crawl to have a variety of textures on which to test some of his perceptual skills...the softness of a carpet, the hardness of vinyl, the warm feeling of carpeting, the cold of vinyl.

The contrast between a soft and hard flooring helps older children in defining areas of quiet work and those for more group and noisy work. The area for books and individual listening centers would be appropriately defined by a throw rug or carpeting; the area for block play with small hand wheel toys would be more efficient if it were on a perfectly flat, smooth surface. If an easel is set up for indoor painting, the children should feel free to paint and not be worried by occasional drips and drops onto the floor, therefore a surface that could be easily cleaned should be planned. Some childrens' centers have placed a drain in the center of the room so that the floor may be hosed and squeegeed for easy maintenance.

Flooring may be used as part of the educational programming:

It may denote a particular area of play and/or work.

It may serve as part of the sensory experiences planned for the children:

- hard and soft
- slippery or rough
- quiet and noisy
- cool and warm
- resilient and rigid

It may serve as a surface for buildings, games, crawling, dancing, studying or resting.

There is a trend toward using indoor carpeting as floor cover for children's programs because of its low cost and easy maintenance. However, wall-to-wall carpeting may inhibit water and messy activities so necessary for young children's programs. In addition, dirty carpeting is not as noticeable as dirt on smooth surfaced floors and the tendency to have a build-up of dirt and dust with carpeting must be recognized. Cotton rugs which may be tossed into a washing machine frequently, are certainly more suitable for infants' rooms than wall-to-wall carpeting.

b) - D o o r s:

Local and state regulations must be adhered to in the planning of doors or exits for programs for young children. Safety is one of the important criterion that must be incorporated into any design. All doors should open out and should have safety glass in them, if glass is to be used. Other factors to take into account:

- Where should the door-knob be placed?

- In an infant room the knob could be placed high on the door for ease in going in and out of the door when infants are being held. A sliding door might be useful and safer than a swinging door.



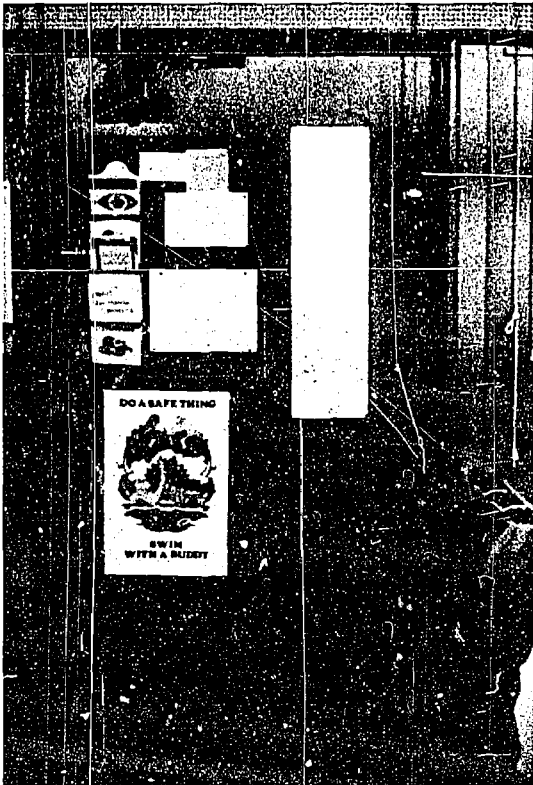

-- In a room for toddlers the door knob leading to the administrative offices or outside might be placed high for safety purposes. The door leading to the play yard may be placed so that the child has access and control.

What kind of lock should be used on the door?

-- For safety reasons, a lock may be necessary. One that may not be used by the children to lock themselves into or out of a room should be used. Use locks that may always be opened from the inside.

Should the doors have glass in them?

-- Often it is desirable to have part of the door be safety and one-way vision glass for observational and light purposes. This

is especially true in situations where a facility is being renovated and there is no provision for an observation room.

-- How wide should the door be?

- Usually state or local regulations prescribe the requirements, however, it is wise to note the number of children to be served, the number of adults who are providing the services and then calculate how much space you would like to have if you wanted to leave the room in a hurry. In an infant's room, the door should be at least a little wider than the width of a crib in order to easily move the children's furniture. Also plan for no door sills for easy maintenance and movement of furniture and equipment.

-- Should closet doors have locks and/or high or low knobs?

- Again, this would depend on the program goals and what is to be stored in the closets. Is it desirable to have the materials in the closet accessible to the crawlers? toddlers? runabouts? preschoolers?

Knobs on cabinets should be placed so that there is no danger of children bumping into them. Recessed pulls should be considered.

c) - W i n d o w s     a n d     V e n t i l a t i o n:

There is a good deal of controversy now as to whether windows are necessary for programs for young children. Building costs go down when windows are not necessary and ventilation can be provided by air-conditioning. This writer feels that windows are an important part of programming for young children and serve the needs of adults as well. "The ability to see outdoors may have some effect on the emotional and psychological development of children. We should not be too quick to separate ourselves from the natural environment."<sup>2</sup>

Windows should be used that have the following qualities:

- safety glass
- open and shut easily
- don't leak water or air
- provide a view without glare
- can be opened without causing a draft on the children
- have a surface that might be used for placement of art materials that could demonstrate opaqueness and transparency

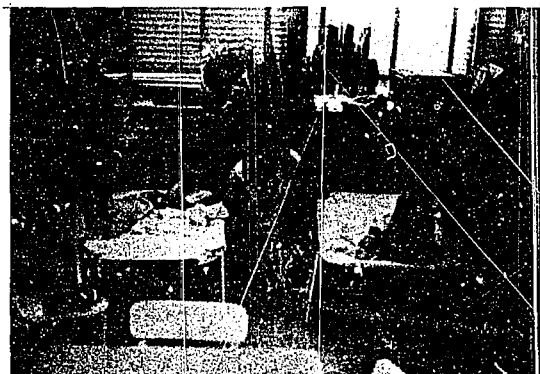

<sup>2</sup>Gardner, Dwayne E., op. cit., p. 6.

Other factors that should be considered center around the use of windows for the children to observe seasonal changes, interesting happenings that occur in the immediate surroundings. Infants delight in watching older children playing and the need for adults to observe children from the outside in or the inside out is imperative.

How low should the windows be placed and still observe sensible rules of safety? Children must be protected and safe and still be able to see outside.

One center with no windows, improvised one by framing a part of the wall, placing a large color photograph of an outdoor scene and hanging curtains over part of the "framed window."

d) - S t o r a g e:

There are several kinds of indoor storage to which attention should be paid in planning a children's program:

Adult storage ...

- Staff's personal belongings, such as wraps and change of clothing
- Maintenance supplies and tools
- Personnel and children's records
- Office supplies and materials
- Library for teachers and parents

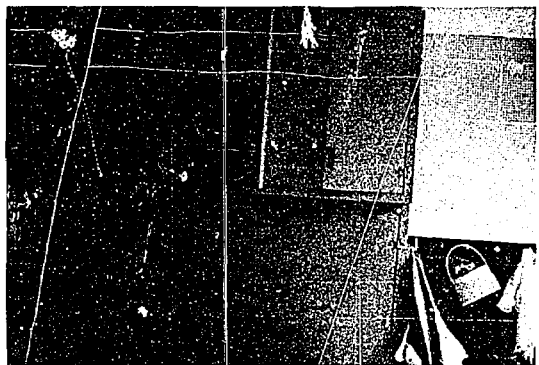

Program storage ...

- Arts and crafts materials  
It is helpful if these supplies are stored near a sink so that such items as paints and clay may be easily prepared and cleaned up.
- Teacher's supplies  
scissors, tools, pins, medical supplies, etc.  
(should be placed out of the reach of the children).

- Audio-visual equipment storing this heavy equipment on movable carts is helpful for backs of staff.

Children's storage . . .

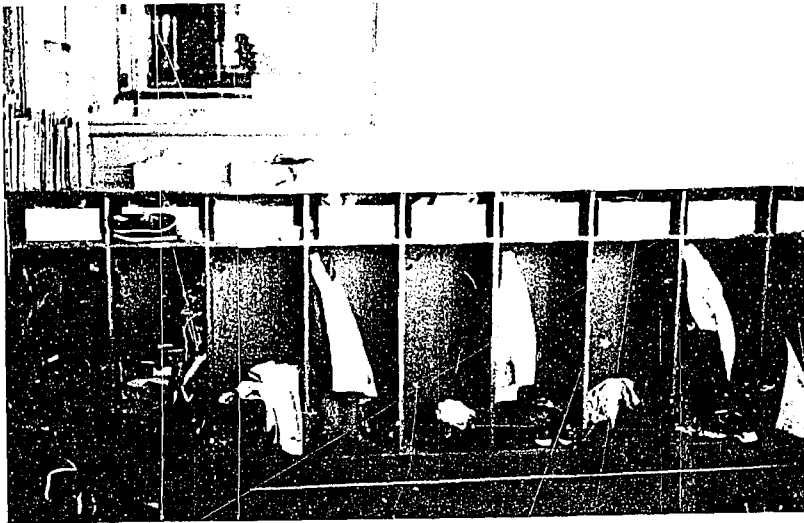

- Children's personal belongings are nicely stored in cubbies  
(Pattern will be described later)

- Change of clothing and diapers  
(Provision should be made for the storing and washing of soiled clothing and diapers)

- Materials used by the children in the daily program should be available on open, movable shelves or near the area in which the materials will be used.



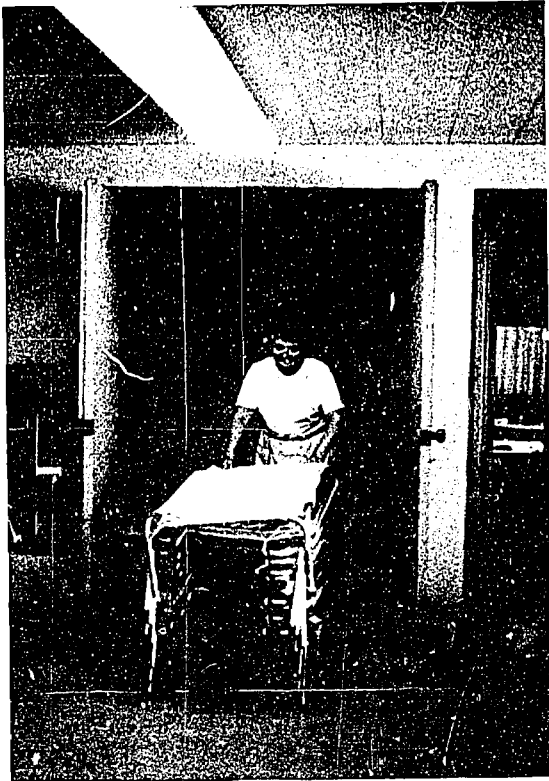

- Sleeping equipment  
and supplies

- Sleeping cots, bedding  
that is soiled and clean,  
sleeping "companions"  
screens, etc., should  
be stored in ventilated  
closets

- Movable storage  
units have the  
advantages that  
static shelves and  
closets may not  
afford.

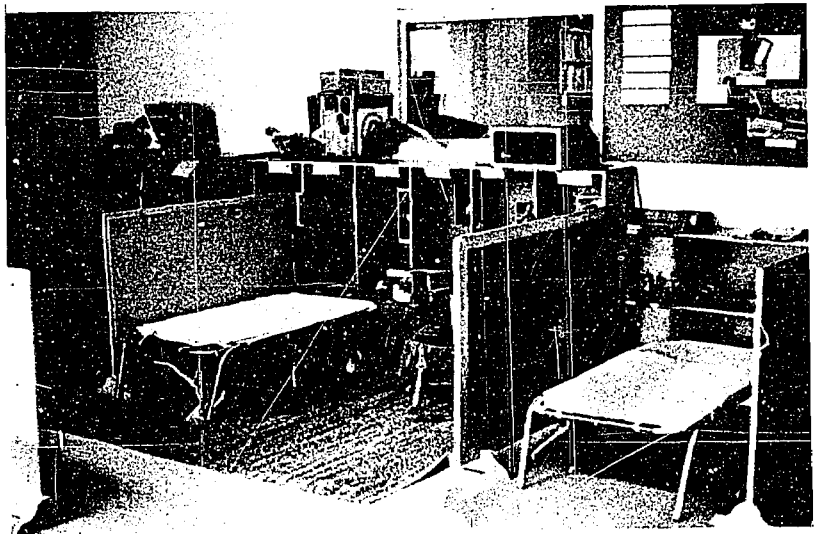

Open and closed shelves that may be easily moved (on ball bearing casters) may serve as room dividers and provide the opportunity of a new kind of room arrangement. (See illustration on page 24). In designing such equipment care must be given to the balance of such storage units, to make sure that they are not "tippy" nor too bulky or heavy (when loaded with supplies or equipment) for teachers to move.

Movable storage units are particularly useful if rooms serve other purposes than just the children's program -- the units may be turned against the wall or moved to another part of the building or room.

e) - L i g h t i n g and

E l e c t r i c a l F i x t u r e s:

Every room should have provision for some kind of artificial lighting, even though daylight may provide adequate light on certain days. The light should provide good illumination without glare...and if possible, an expert in the lighting field should be consulted for guidance. Insufficient or glaring lights can cause eye fatigue or eye damage, in addition to setting a mood for the room and the children. Other important considerations, in planning, should take into account the placement of windows (Northern exposures are desirable) and the colors of the walls and ceiling (light colors make fixtures more effective).

Electrical outlets should be checked by local building and fire and electrical authorities. It is advisable to locate new outlets at adult height and ones that are low should be adequately protected for the safety of the children. Outlets are needed for the operation of audio-visual equipment, cooking equipment, bottle-warmers, aquariums, vacuum cleaners, etc. Some of the appliances that might be installed (such as a small refrigerator in the infants' room) might need heavy duty wiring. Teachers should be discouraged from using extension cords or "octopi" which might put too much stress on the electrical system. The staff should be aware of where the breakers are located for the electrical system and should be instructed in some simple methods of cutting off the system should it become overloaded.

Where new wiring is installed make sure that the electrical box is large enough for future expansion, and is equipped with circuit breakers instead of fuses. A light fixture at the box will help at those times when the breakers must be tripped at night.

f) - Wall-covers and Display Spaces:

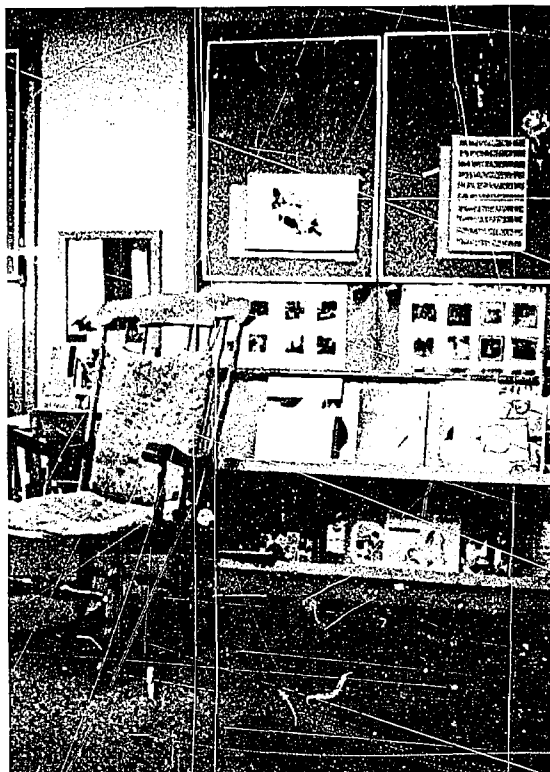

Light, washable, non-poisonous paints should be used on walls in the children's rooms. Heavy duty wall papers that are washable may also be used. Some centers have found laminated plywood veneer paneling (in light wood-tones) have been satisfactory, especially in renovated facilities. Ample space should be provided for display of the children's work. Cork, tack-board, styrofoam covered with burlap have been very useful for these purposes. If the displays are for the children, then locate them at the height that the children will find comfortable to see and touch. It is also important to have displays for parents, staff, and community and of course, these should be placed at adult height. Also consider placing interesting displays for infants at heights that might be observed from their cribs or play pens...this might require hanging mobiles from the ceilings, as well as flat items on the walls.

g) - Children's Bathrooms:

Children's bathrooms should be located, whenever possible adjacent to the rooms where the children play, sleep, and/or eat, indoors and outdoors. Doors should be easily opened and most likely will remain open most of the time for easy adult supervision...probably a floor catch would be advisable on each of the doors that lead to the bathroom.



Toilets should be low (10" to 11" above the floor) and of the one piece variety (for easier cleaning). The kind that hang from the wall allow easy mopping of the floor. Wash basins should also be low enough (24" above the floor) for the children to use comfortably and could be located in the playrooms. In the case of a bathroom to be used for infants, adult toilets and wash basins are probably easier for adult use. In some states it is required that one bathtub be installed in a center for children...this may come in quite handy, if a bath is required for a child (and this frequently does happen). Bathinettes or small tubs should be provided if infants are cared for over a few hours a day.

Paper towels and wastebaskets should be placed near wash basins so that the walking child may easily reach them. Soft wash cloths for each child may be used in addition to paper towels. Provision should be made so that cloth towels may be hung for airing and the hooks or hangers should be marked with the child's name (to insure use by only one child).



A nonbreakable mirror placed over a wash basin serves many functions...a child may see where he needs to wash himself, it may be used by the teacher to help children identify parts of his body and it is fun to wash with soapy suds.

There should be some provision in each bathroom for storage of housekeeping items like toilet paper, soap, paper towels, mops in case of an accident, brooms, cleansers, etc.



The floors of the bathrooms and playrooms should be durable, non-slippery, capable of receiving a lot of water and ideally would have a drain to take care of excess water. Good light and ventilation is essential.

The toilets and the wash basin should have easy access to traps that will make it easy to remove excess sand, paper-towels, small toys, etc.

#### h) - k i t c h e n s:

The kitchen can be one of the most important rooms for the children's program. The older children love to visit the kitchen and the cook where all of the "goodies" are dispensed for juice-time, snacks or lunch. The kitchen should be located close enough to the children's rooms so that the transporting

of food can be done quickly and with a minimum of confusion (carts with trays are convenient for this purpose). It should also be located close to a convenient delivery area so that groceries may be easily delivered and refuse may be easily disposed of. Sometimes a pass-through directly to the children's rooms can be arranged from the kitchen, however, smells of cooking (which can be considered an advantage or disadvantage) and the clatter of dishes may be points to consider.

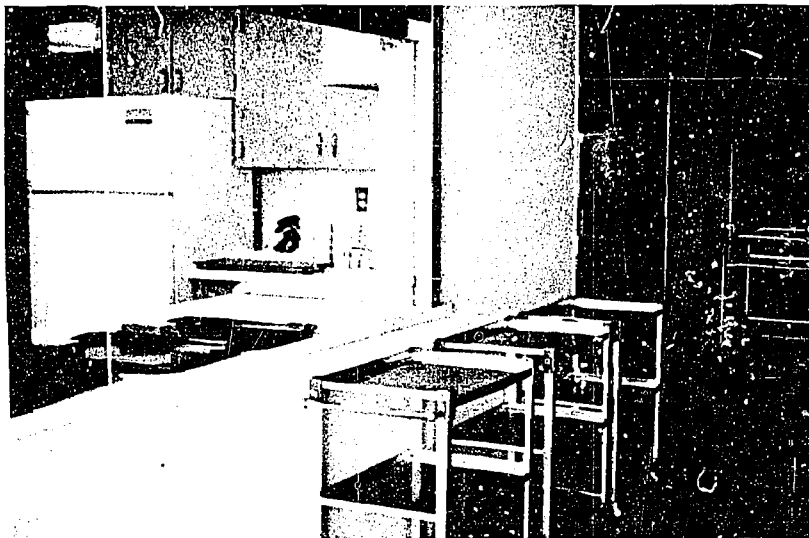

Kitchens should provide adequate counter space, as well as cooking facilities for the service of foods to young children that may be served family-style.

Plates may be disposable (in which case there should be adequate containers for the disposal of paper goods) or plastic (in which case provision must be made for sterilization).

The kitchen may also serve as a demonstration center for parents in the preparation of foods for the family. If this is the case then the planners will have to take into account the need for extra floor and counter space.



Some centers will not offer meals and then the kitchen facility will not have to be extensive, but some provision should be made for the preparation and storing of juice and crackers and any of the other snacks that might be served. In any case, consultation with local health authorities is an important part of any kind of service of foods for young children.

## OUTDOOR DESIGN

The outdoor area should also provide a variety of textures, patterns and experiences for the children. The age of the children will determine to a large extent the kind, size and quantity of equipment and space, and specifics will be described later in discussing the various age groups to be served. However, we can state that it is desirable to enlarge the space provided the children as they grow older. Space should be adequately defined in order to protect various age groups from each other.

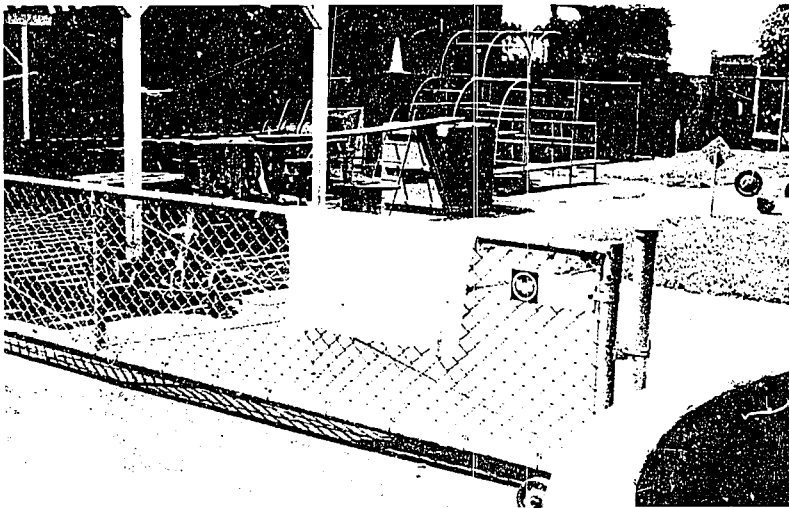

The younger the child, the more he needs a well-defined space with familiar objects that may be handled or mastered.

As the child grows and develops, more challenges must be provided that correspond to his growing curiosity and feelings of reaching out into the world.

Infants should be provided with a protected environment that will provide visual, aural and kinesthetic experiences appropriate for babies.

In the outdoor areas for toddlers, runabouts, and preschoolers, variations of the same kinds of general programs and equipment should be planned.

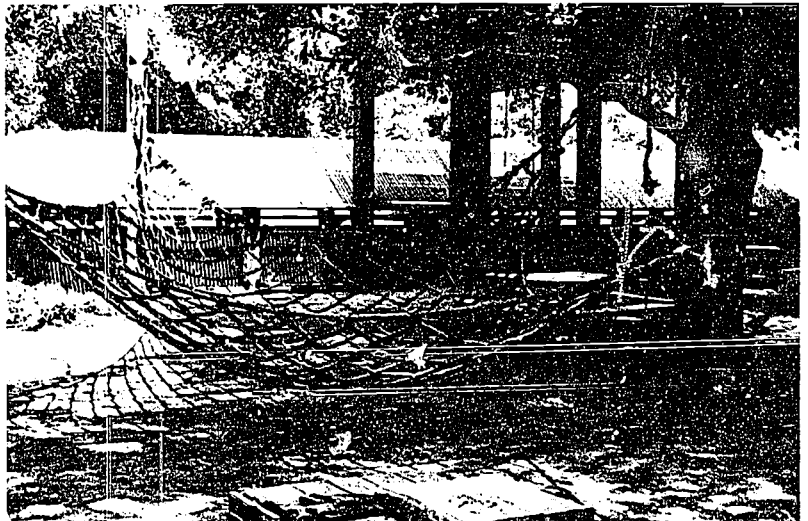

These are some of the areas for which space should be considered:

-- sand, water and digging area

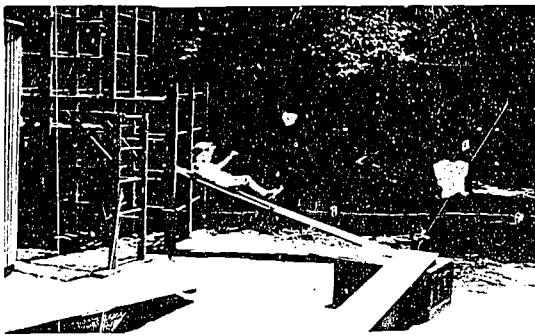

-- climbing and crawling area

-- wheel toy area with "roads" and paths

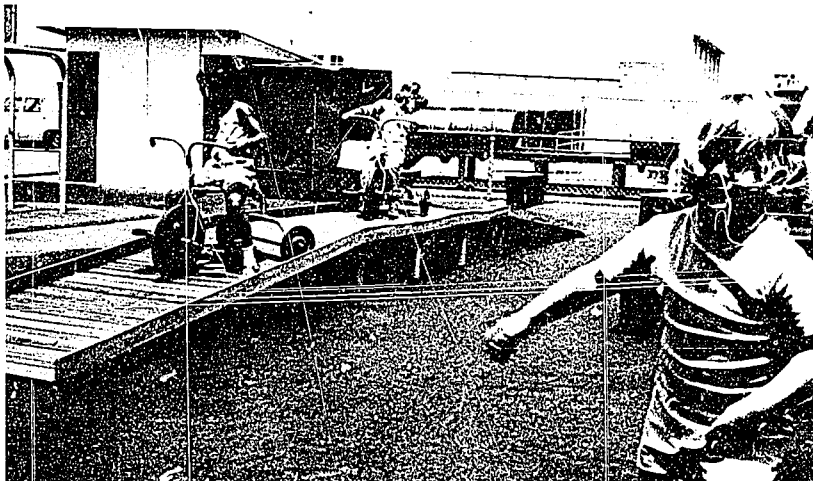
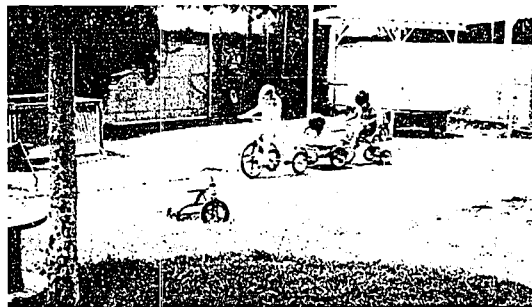

-- painting  
with  
easels

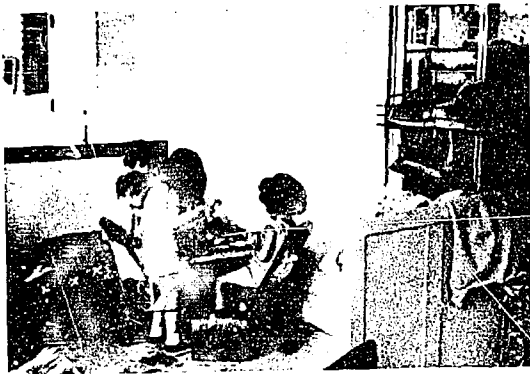

-- housekeeping  
and  
dramatic play area

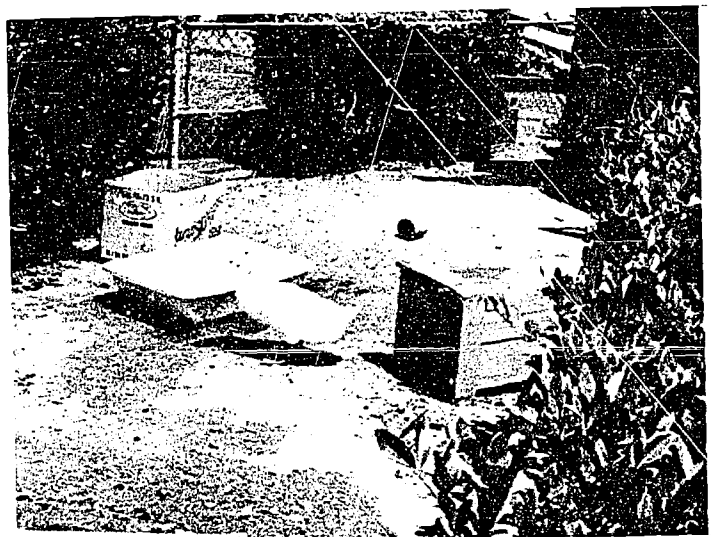

-- farm and planting area

- table work area,  
including:

creative art,  
table activities,  
and woodworking



- outdoor blocks

- swings

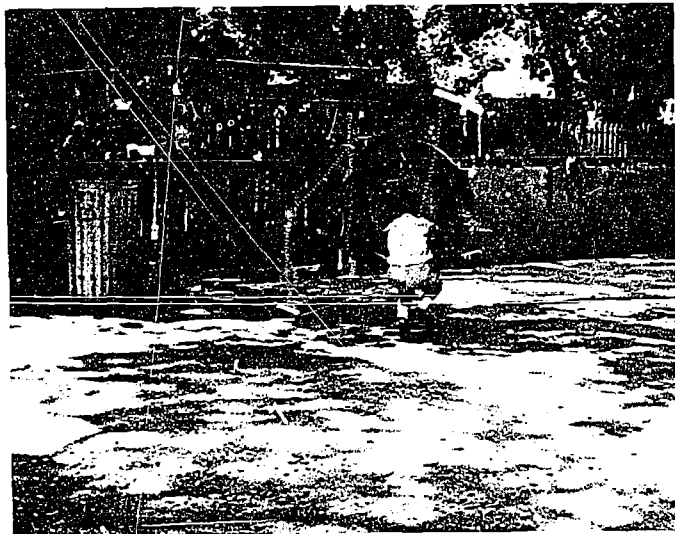



-- swings

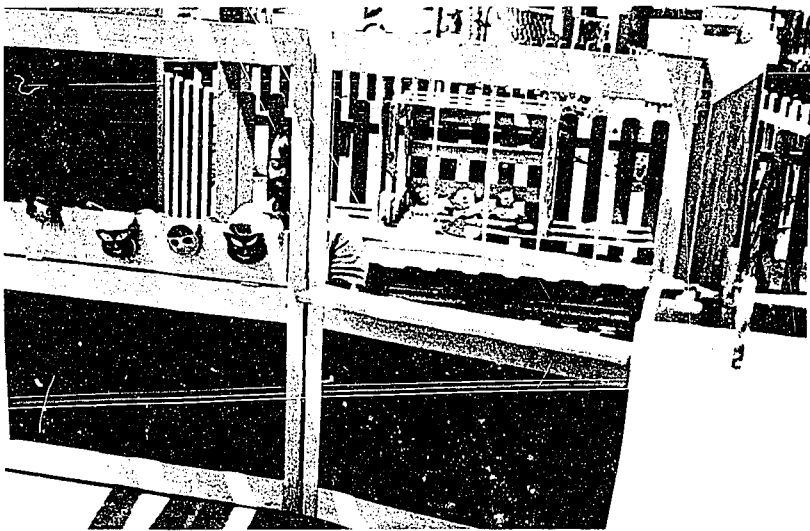

-- books and stories

-- rhythms and music

In thinking about the outdoor area, Friedberg described what the experience should be for older children, and much of what he says applies to the planning for the young child:

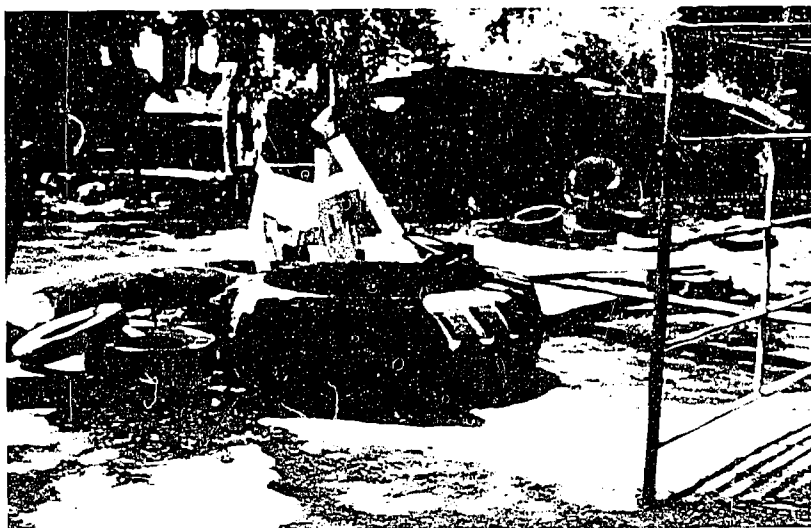

"A playground should be a sensuous textile woven of touch, smell, sight, hearing and (but that it could!) taste. Areas of differing color, varying textures and resonance should be built into the armature of topography. There is a conscious approach to tactile variation in the use of different materials. Wood and stone provide contrast to the sense of touch; there is cold, hard concrete and sunwarmed sand. In the frame bordering this setting there could be planted flowers to smell!

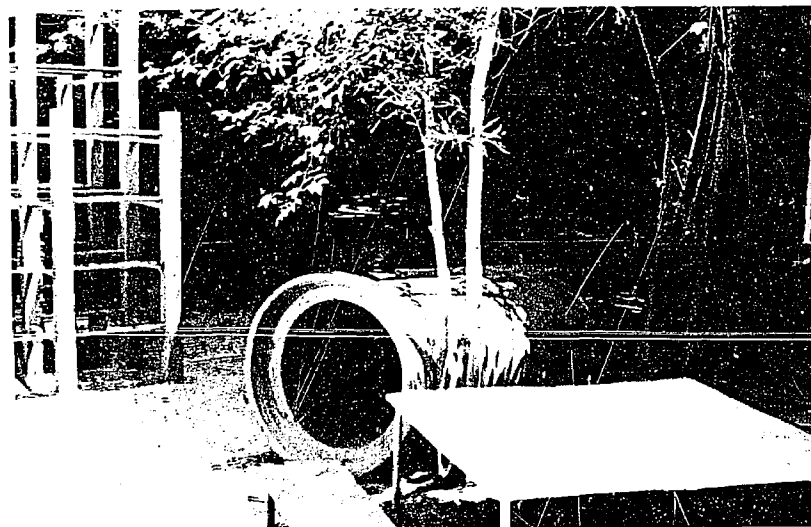

There might be banners to be hung and murals to be painted. For something to listen to, a series of oil drums of different heights, each producing a different sound, can be jumped or banged upon.



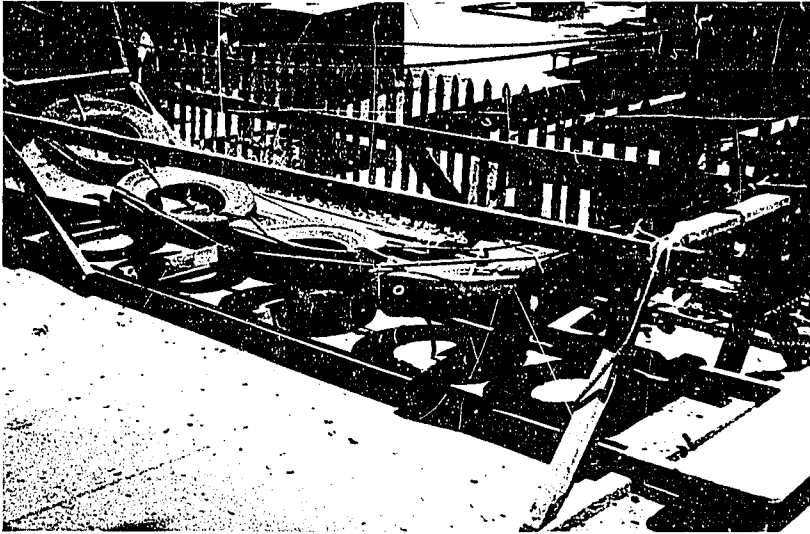

A playground should have challenge. All too often the consideration of safety limits the degree of challenge to the child.

Challenge prepares a child for maturity by developing a knowledge of his personal capabilities. He finds out how high he can go, how long he can balance, the extent of his endurance and the foolishness of overextending himself.

Challenge creates the basic interest for a child at play, and

physical challenge is a major portion of this interest. The mastery of challenge is an accomplishment and can be developed by the creation of a series of preliminary steps that prepare one for the final goal. If the design does not allow for gradual orientation and the development of experience, then the progression is out of balance. Challenge becomes dangerous only when the child overextends himself.

Safety is, naturally, a major concern of the parent. A playground should be safe but not at the expense of experience, for play is a part of preparation for the reality of mature life with its built-in dangers ...."<sup>3</sup>

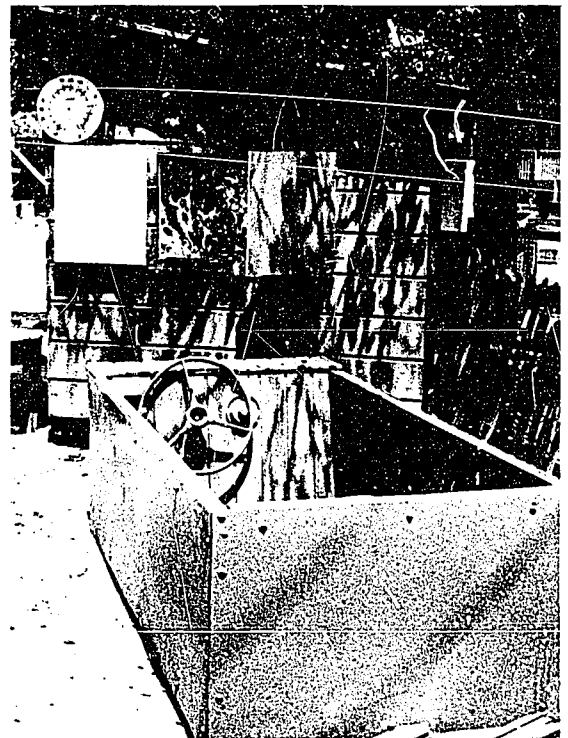

<sup>3</sup>Friedberg, M. Paul, Playgrounds for City Children, (Washington, D.C.: Association for Childhood Education, International, 1968) p.9.

a) - S a f e t y:

Let us examine some of the check-points of safety that must be considered before any discussion of the outdoor area. While it is true that there must be a balance between safety and providing exciting and educational experiences, there are certain precautions that must be taken in the planning for young children:

- 1) Is the outdoor area one that may be easily supervised by the staff members? ... If there are too many nooks and crannies children may not be seen and the staff may have to spend a good deal of time trying to account for "lost" children. The area should be planned so that the size and arrangement should correspond to the size and capabilities of staff and children.
- 2) Is the outdoor area adequately enclosed? Protection from traffic and wandering off is important for the children and staff. If the teacher must constantly be aware of keeping the children within boundaries, she is not then able to attend to other teaching activities.



The enclosure of a yard can be helpful to young children, providing them with boundaries that make them feel more at ease. Needless to say, the enclosure should be made of a material that is pleasant to the eye and doesn't give the feeling of being forbidding and heavy. Wire fences that are sturdy, but permit air and light to come through are desirable ... and may be used as a trellis for plants.

- 3) Is the outdoor area free of dangerous objects? Often after construction or renovation, there are sharp objects such as nails and broken glass in and on the ground ... these must be eliminated before children are permitted outdoors.
- 4) Is the area where falls are most likely to take place adequately cushioned? The ground beneath swings, jungle gyms and other climbing equipment should be covered with resilient materials such as heavy-duty rubber squares, sand or grass, or tanbark.
- 5) Is there a bathroom adjacent to the play yard? This placement becomes important when children need some quick first-aid or have a toileting accident.
- 6) Is all of the planting non-poisonous? Some berries and leaves of shrubs and trees are toxic -- be sure that you do not use oleander, puce trees, hollyhocks, castor beans and others. (Check with local health department for other poisonous plants.)

b) - G r o u n d C o v e r:

There are a variety of ground covers available for safe and comfortable use of young children. They provide texture and the kinds of experiences necessary for an educational program.

The children should have the experience of a soft surface for rolling, falling, sitting and lying upon; a hard surface for wheel toys, ball-playing and block building; and a just plain dirt area for digging, and water play, and planting.

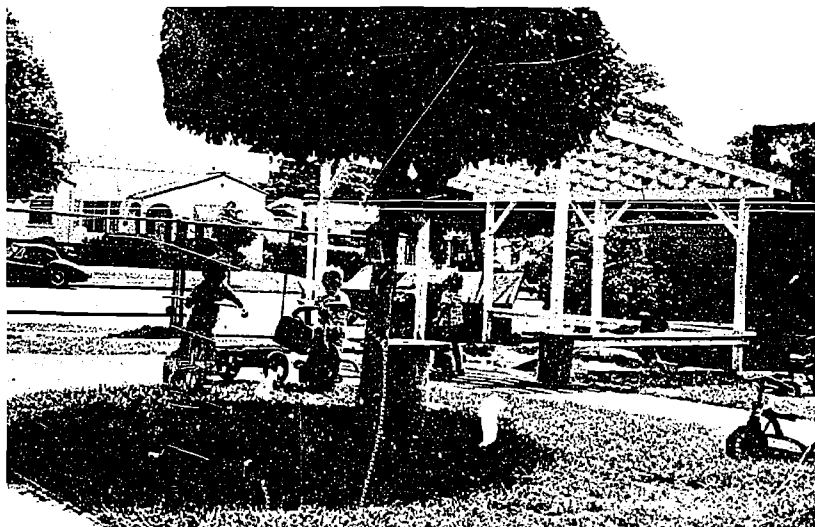

| TYPE OF GROUND COVER  | ADVANTAGES   | DISADVANTAGES   |
|---|--|---|
| Sand -- in one designated area                                    | resilient, good for imaginative play, pouring, digging                       | dries slowly, needs replacement                       |
| Grass   | resilient; cool, good for sitting, quiet activities                          | needs care (watering, cutting, seeding); dewy and wet |
| Tanbark - under climbing and swinging equipment                   | resilient; textured; dry (drains well)                                       | can burn  |
| Stone   | textured; good for imaginative play  | hard; slippery when wet; falls are dangerous          |
| Black top (asphalt)   | textured, good for wheel toys; good drainage (if properly installed)         | hot; falls are dangerous; hard                        |
| Concrete  | easily cleaned; smooth surface   | hard; falls are dangerous; slippery when wet          |
| Brick   | textured; good drainage  | hard; uneven; falls are dangerous                     |
| Decomposed granite  | resilient; good drainage; textured; needs little upkeep; good for wheel toys | needs replacing                                       |
| Heavy Duty Rubber Squares - under climbing and swinging equipment | resilient; level; easily cleaned   | expensive   |

c) - T e m p e r a t u r e C o n t r o l:

The climatic conditions of the area very much dictate the kind of outdoor program that is planned. Extremes in temperature are difficult for young children and times of temperature weather should be seized upon for planning the outdoor program. Some considerations are:

- 1) Plan for outdoor storage for clothes changes for the children (and sometimes the teachers as well), should the weather be cold (and the child needs some additional or a change of clothing) or hot (and the children have a lot of water play and need to change to dry clothes). Items such as plastic aprons for painting and clothes for dramatic play are more easily stored outdoors, if they are to be used there.



- 2) Plan for sunshine and shade. Not only is the light variation important in providing these contrasts, but comfort is also an important ingredient. By locating the play-yard on the South side of the building, sunlight is insured. Trees or shades that have been fireproofed provide the needed shade.



- 3) If the area is windy, windbreaks should be planned. (check with the local nursery) or a fencing material that will cut the wind should help to solve this problem.

d) - A c o u s t i c s:

The location and placement of programs and equipment in the outdoor area should be carefully planned. Some activities are noisy and raucous, other quiet and sedate, others solitary and still others are best accomplished in groups. Those activities that are loud should probably be placed as far away from the building as possible, in order not to disturb those that might be inside. Sedentary activities are best placed closer to the building and in a cozy, protected setting. For example, the building blocks and wheel toys are likely to encourage busy, group activity; easel painting and table work are likely to encourage quiet, individual work (of course there are exceptions to these examples.)

e) - L i g h t i n g, P l u m b i n g,  
and E l e c t r i c a l O u t l e t s:

Outdoor lighting and electrical outlets should be checked by local inspections for safety. It is helpful to plan outdoor lighting so that if there is any need for work to be done in the evenings or should the parents wish to plan some outdoor event or meeting, the facilities will have adequate light. Outlets are very handy for such things as record players and electrical tools for repairing equipment. The outlets should be placed beyond the children's reach and should be covered to protect them from weathering.

Hose bibs should be placed in numerous places (just think of all of the places where water will be used...) and a low-drinking fountain for the children is useful.



f) - S t o r a g e:

The kind of outdoor storage is largely dependent on the climatic conditions and the space available. In many areas no equipment may be left outside and everything must be stored...in milder climates, much of the equipment may be left uncovered. Storage rooms that will accommodate wheel toys, tables and chairs, sand equipment and other outdoor items are well placed adjacent to the the play-yard.

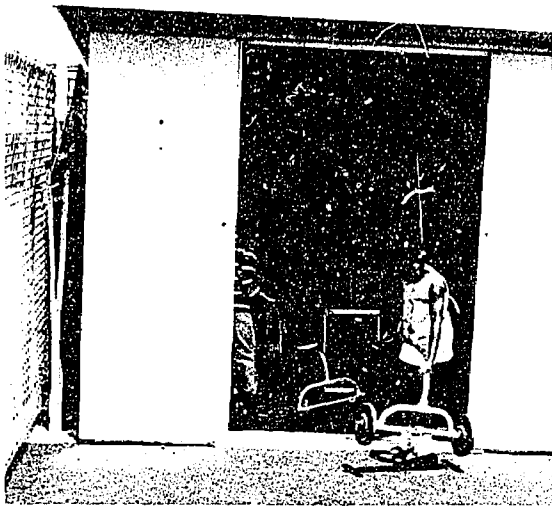

Where no large storage room is built, portable units are available from department stores.

In milder climates, overhangs may be added to existing structures to provide some cover for equipment.

Usually equipment and supplies that are used outdoors are chosen for their durability or are expendable (example: many teachers use doll dishes that have already been used for the indoor program and are ready to be subjected to mud and sand play).

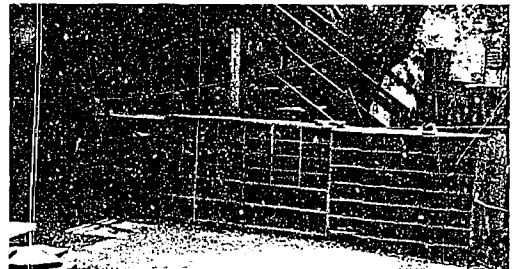

Most teachers try to keep indoor and outdoor equipment separated, and outdoor storage helps implement this notion.

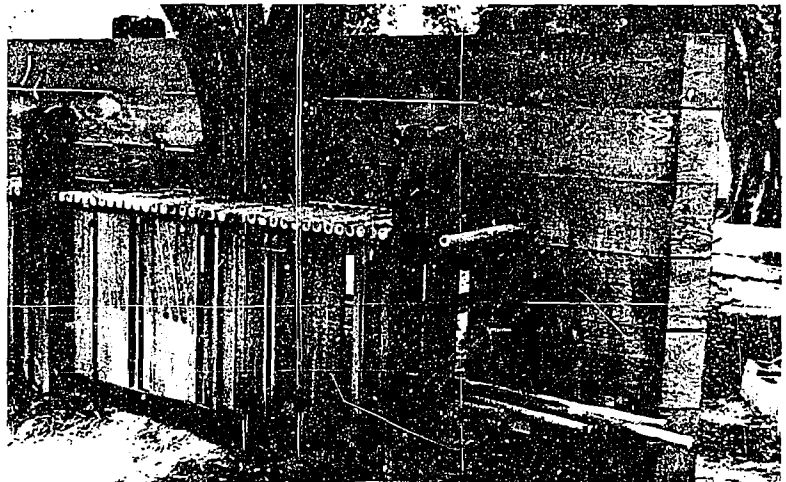

A dolly, wagon, or garden cart is useful in helping to move heavy materials in and out of the storage areas. Boxes on wheels with hand pulls can be used for rolling out unit blocks.

Vegetable and/or fruit crates may be stacked and filled with table toys, art materials, and other small equipment for outdoor storage.



g) - A n O u t d o o r C h e c k l i s t

| PROGRAM          | EQUIPMENT AND SUPPLIES  | SUPPLEMENTARY MATERIALS   |
|------------------|---|---|
| Sand and Digging | <p>A sand box 8' x 10'</p> <p>A sand mound or soft digging dirt</p> <p>Sand may be placed into plastic pools, truck tire halves, plastic washtubs, sand tables with construction sand</p>   | <p>Transportation toys</p> <p>Aluminum pots, pans, scoops, strainers, plastic bottles, paint buckets, pails, shovels, graduated measuring containers.</p> <p>(No glass, rusting metal or sharp edges)</p>   |
| Water            | <p>A water table</p> <p>Plastic wading pools (If pools are to be used, water must be emptied every day and surface should never be permitted to become slippery or slimy)</p> <p>Plastic washtubs</p> <p>Faucet with a light-weight hose for gardening</p> <p>Pails with 3 inch paint brushes</p> | <p>Set up a car wash with wheel toys</p> <p>Washing dolls, dishes and clothes in soapy water</p> <p>Blowing bubbles (no detergents)</p> <p>Water painting</p> <p>Sprinkler on hose for cooling off in hot weather (Have towels handy)</p> <p>Plastic aprons to be worn on damp or cool days</p> |
| Climbing         | <p>Jungle gym</p> <p>Finished wooden crates</p> <p>Climbing boards and platforms</p> <p>Wood cleted ladders</p> <p>Abstract sculpture</p> <p>Low sturdy trees</p> <p>Oil drums</p> <p>Barrels</p>   | <p>All of these items that are wood must be sanded and kept smooth.</p> <p>Varnishing and/or painting is helpful.</p>   |

| PROGRAM             | EQUIPMENT AND SUPPLIES   | SUPPLEMENTARY MATERIALS   |
|---------------------|--|---|
| Wheel toys          | Tricycles<br>Wagons<br>Go-Carts<br>Fire Engine<br>Wheelbarrows<br>Buggies  | Equipment for a make-believe gas station, fire station, etc.<br><br>Rope for pulling<br><br>Dolls and dramatic play equipment   |
| Table Work          | Outdoor tables<br>Outdoor chairs<br><br>Finger painting, collage, clay, dough, cooking                             | Small table toys, dishes, etc.<br><br>A bucket of warm, soapy water and sponges for the children to wash their hands and for the teacher to use for cleaning table<br><br>(Sponges can be kept clean and fresh by washing in water and baking soda)<br><br>Paper towels |
| Woodwork            | A wooden table that will hold a vise, or C-Clamp<br><br>Hammers<br><br>Saws<br><br>Nails<br><br>Wood and sandpaper | Broom and dust pan to pick up scraps<br><br>Magnet to pick up loose nails   |
| Painting with Easel | Easel<br>Paper<br>Paint and brushes  | Some arrangement for hanging the paintings to dry<br><br>(Clothesline, fence with clothespins handy)<br><br>Bucket of warm soapy water with sponges and paper towels  |

| PROGRAM                         | EQUIPMENT AND SUPPLIES  | SUPPLEMENTARY MATERIALS  |
|---------------------------------|---|--|
| House-keeping and Dramatic Play | Dress-up<br><br>Dramatic play toys and equipment such as stove, sink, doll beds, etc. | Large hollow blocks may be used to block off an area for dramatic play   |
| Farm and Planting               | Animals<br>Pens for animals<br>Digging tools<br>Seeds<br>Hose for watering            | Equipment for cleaning pens and caring for animals<br><br>Marking off planting area with some blocks will give new plants a chance to grow |
| Outdoor Blocks                  | Hollow blocks   | Sawhorses and cleated boards and ladders help to extend the use of blocks<br><br>Dramatic play materials                                   |
| Books and Stories               | Books<br>Blankets or mats<br>Children's chairs  | Keeping some favorite children's books in a cart or basket that is accessible for the children   |
| Rhythms and Music               | Musical Instruments<br><br>Record player  | Setting aside an area that will not be disturbed by wheel toys or other activities is helpful  |
| Swings                          | Swings  |  |

## EQUIPMENT AND SUPPLIES

The following list of equipment and supplies has been divided according to traditional indoor and outdoor activities. Some of the materials might just as easily be used interchangeable indoors and outdoors i.e., woodworking, dramatic play, arts and crafts, etc. The quantities are based on the following number of children and age groupings:

| NO. OF CHILDREN | AGE OF CHILDREN                             | *APPROXIMATE COST OF EQUIPMENT AND SUPPLIES |
|-----------------|---|---|
| 5               | Infants -<br>6 months<br>to 18 months       | \$ 1,600.00                                 |
| 10              | Toddlers -<br>18 months<br>to 2 1/2 years   | 1,900.00                                    |
| 15              | Preschoolers -<br>2 1/2 years<br>to 6 years | 2,600.00                                    |

\* The approximate cost (which will vary by region and changing prices) is based on prices of March, 1970 and does not include office equipment, rental, etc.

**INDOOR EQUIPMENT AND SUPPLIES**

| Item  | Quantity<br>for |                  |                      |
|---|-----------------|------------------|----------------------|
|   | Infants<br>(5)  | Toddlers<br>(10) | Preschoolers<br>(15) |
| <b>BASIC FURNITURE &amp; EQUIPMENT:</b>   |                 |                  |                      |
| Wall Clock  | 1               | 1                | 1                    |
| Play Pen  | 1               |                  |                      |
| Baby Walker   | 1               |                  |                      |
| Twin Stroller   | 2               |                  |                      |
| Boston Rocker (adult size)  | 1               | 1                | 1                    |
| Boston Rocker (children's size)   |                 | 2                | 2                    |
| Cubbies or Lockers  |                 | 10               | 15                   |
| Shelves (double and portable on<br>ball bearing casters)  |                 | 3 or 4           | 4 or 5               |
| Tables (20" high to seat 6 at table)  |                 | 2                |                      |
| Chairs (low height for 20" tables)  |                 | 14               |                      |
| Tables (22" - 24" high to seat 6 at table)  |                 |                  | 3                    |
| Chairs (low height-for 2" to 24" Tables)  |                 |                  | 20                   |
| 2" Foam Pads 26" x 54" - (used as floor<br>cover for indoor climbing or<br>sitting activities)                  | 2               | 5                |                      |
| <b>SLEEPING AND RESTING:</b>  |                 |                  |                      |
| Cribs   | 5               |                  |                      |
| Crib Mattresses   | 5               |                  |                      |
| Portable cribs (for outdoor use)  | 2               |                  |                      |
| Fitted crib sheets  | 3 doz.          |                  |                      |
| Crib Bumpers  | 5 sets          |                  |                      |
| Crib Mattress Pads  | 10              |                  |                      |
| Crib Blankets   | 2 doz.          |                  |                      |
| Receiving Blankets  | 12              |                  |                      |
| Screens (for privacy at nap time)   | 3               | 5                | 6                    |
| Saran Cots  |                 | 10               | 15                   |
| Cot Sheets  |                 | 3 doz.           | 4 doz.               |
| Cot Blankets  |                 | 2 doz.           | 3 doz.               |
| <b>WASHING AND TOILETING:</b>   |                 |                  |                      |
| Bathinettes   | 2               |                  |                      |
| Training Chairs   | 2               |                  |                      |
| Diapering table and storage unit  | 1               |                  |                      |
| Clothes Hamper (ventilated)   | 1               | 1                | 1                    |
| Diapers (local diaper service<br>is desirable. Service<br>will sometimes provide an<br>extra supply of diapers) | 25 doz.         |                  |                      |
| Finger-tip Towels   |                 | 4 doz.           | 6 doz.               |
| Bath Towels   |                 | 20               | 30                   |
| Washcloths  |                 | 4 doz.           | 6 doz.               |
| Training Pants  |                 | 4 doz.           |                      |
| Underpants  |                 |                  | 2 doz.               |
| Wastebaskets (for paper towels<br>in bathroom)  | 1               | 2                | 4                    |

**INDOOR EQUIPMENT AND SUPPLIES**

| Item  | Quantity<br>for |                  |                      |
|---|-----------------|------------------|----------------------|
|   | Infants<br>(5)  | Toddlers<br>(10) | Preschoolers<br>(15) |
| <b>EATING AND SNACKS:</b>   |                 |                  |                      |
| Counter Refrigerator (for storage of bottles of milk for infants) | 1               |                  |                      |
| Felt Lap Pads   | 3 doz.          |                  |                      |
| Bibs  | 3 doz.          |                  |                      |
| High Chair  | 2               |                  |                      |
| Play and Feed Table   | 1               |                  |                      |
| Baskets or Trays (for snacks)                                     |                 | 3                | 4                    |
| Pitchers (for juice and milk)                                     |                 | 2                | 3                    |
| Utensils, plates, cups, etc.                                      | x               | x                | x                    |
| <b>INFANT ACTIVITIES:</b>   |                 |                  |                      |
| Infant sensory developer stand                                    | 1               |                  |                      |
| Cradle gym or mobile for cribs                                    | 3               |                  |                      |
| Texture ball  | 1               |                  |                      |
| Dumbbell rattles  | 2               |                  |                      |
| Teething rings  | 5               |                  |                      |
| Pram beads  | 1               |                  |                      |
| Suction Beads   | 2               |                  |                      |
| Disc Rattle   | 2               |                  |                      |
| Infant Chimes Mobile  | 1               |                  |                      |
| Playball Assortment   | 1 pk.<br>of 4   |                  |                      |
| See-Thru Animal Blocks  | 1 set<br>of 6   |                  |                      |
| Cloth Foam Blocks   | 1 set           |                  |                      |
| Roll-a-wheel  | 1               |                  |                      |
| Fun-nee Men   | 2               |                  |                      |
| Roly Polys  | 3               |                  |                      |
| Building Beakers  | 1               |                  |                      |
| Squeeze toys  | 5               |                  |                      |
| Clutch balls  | 3               |                  |                      |
| Pull Toys   | 3               |                  |                      |
| <b>MUSIC:</b>   |                 |                  |                      |
| Record players  | 1               | 1                | 1                    |
| Auto-harp and/or Guitar and/or Piano                              | 1               | 1                | 1                    |
| Tambourines   |                 | 4                | 4                    |
| Bells   |                 | 4                | 4                    |
| Drums   |                 | 4                | 4                    |
| Triangles   |                 |                  | 4                    |
| Sound Blocks  |                 |                  | 2                    |
| Jingle Clogs  |                 |                  | 2                    |
| Rhythm Sticks   |                 |                  | 2                    |
| Song Books  |                 | 1                | 2                    |

**INDOOR EQUIPMENT AND SUPPLIES**

| Item  | Quantity for |               |                   |
|---|--------------|---------------|-------------------|
|   | Infants (5)  | Toddlers (10) | Preschoolers (15) |
| <b>DRAMATIC PLAY</b>                                  |              |               |                   |
| Negro dolls-rubber, eating and wetting baby dolls     | 1            | 2             | 4                 |
| Caucasian dolls-rubber, eating and wetting baby dolls | 1            | 2             | 4                 |
| Doll carriage   |              | 1             | 3                 |
| Doll clothes  |              | 4 sets        | 8 sets            |
| Receiving blankets                                    |              | 2             | 4                 |
| Pillow  |              | 1             | 2                 |
| Pieces colorful fabric 1 yd x 1 yd                    |              | 4             | 4                 |
| Doll bed  |              | 1             | 2                 |
| Plastic doll dishes                                   |              | 2 sets        | 3 sets            |
| Pots and pans   |              | 1 set         | 3 sets            |
| Storage shelf   |              | 1             | 2                 |
| Play stove  |              | 1             | 1                 |
| Small table   |              | 1             | 2                 |
| Small chairs  |              | 2             | 4                 |
| Plastic telephones                                    |              | 2             | 4                 |
| Ironing Board   |              | 1             | 2                 |
| Small plastic wood or metal irons                     |              | 2             | 3                 |
| Full-length mirror (unbreakable)                      |              | 1             | 1                 |
| Short-handled broom                                   |              | 2             | 4                 |
| Dishpan   |              | 1             | 2                 |
| Short-handled mops                                    |              | 2             | 4                 |
| Dustpan   |              | 1             | 2                 |
| Cutlery utensils (plastic)                            |              | 1 set         | 3 sets            |
| Clothesline (1 length)                                |              |               | 1                 |
| Clothespins   |              |               | 1 doz.            |
| <u>Dress-up clothes:</u>                              |              |               |                   |
| Man's hat   |              | 2             | 4                 |
| Brief Case  |              | 1             | 2                 |
| Necktie   |              | 2             | 4                 |
| Shoes   |              | 2 prs         | 4 prs.            |
| Uniforms (scouts, police, etc.)                       |              | 1             | 2                 |
| Occupation hats (fireman, cowboy, sailor, etc.)       |              | 2             | 4                 |
| Man's jacket  |              | 1             | 2                 |
| Woman's hat   |              | 2             | 4                 |
| Purse   |              | 2             | 4                 |
| Petticoat   |              | 1             | 2                 |
| High Heeled Shoes                                     |              | 2             | 4                 |
| Long Skirt  |              | 2             | 4                 |
| Costume Jewelry                                       |              | x             | x                 |
| <b>BOOKS AND STORIES:</b>                             |              |               |                   |
| Book display stand                                    |              | 1             | 1                 |
| Books   | 6            | 20-30         | 30-40             |
| Tables and chairs                                     | SEE ABOVE    |               |                   |
| Rug or pad for seating                                | SEE ABOVE    |               |                   |

**INDOOR EQUIPMENT AND SUPPLIES**

| Item   | Quantity for |               |                   |
|--|--------------|---------------|-------------------|
|  | Infants (5)  | Toddlers (10) | Preschoolers (15) |
| <b>BLOCK BUILDING:</b>                           |              |               |                   |
| <b>Unit Blocks</b>                               |              |               |                   |
| Quadruple units                                  |              | 48            | 96                |
| Double units                                     |              | 96            | 108               |
| Single units                                     |              | 108           | 108               |
| Half units                                       |              | 48            | 96                |
| Pillars  |              | 24            | 48                |
| Large cylinders                                  |              | 6             | 12                |
| Large triangles                                  |              | 4 pr.         | 8 pr.             |
| Small triangles                                  |              | 8 pr.         | 16 pr.            |
| Elliptical curves                                |              | 8             | 16                |
| Small ramps                                      |              | 12            | 24                |
| <b>BLOCK BUILDING ACCESSORIES:</b>               |              |               |                   |
| Family doll figures                              |              | 1 set         | 2 sets            |
| Miniature cars                                   |              | 1 bag         | 2 bags            |
| Miniature planes                                 |              | 1 bag         | 2 bags            |
| Community working figures                        |              | 1 bag         | 2 bags            |
| Miniature sail and other boats                   |              | 1 bag         | 1 bag             |
| Cowboys and Indians                              |              |               | 1 bag             |
| Sailors, army men or knights                     |              |               | 1 bag             |
| Prehistoric animals                              |              |               | 1 bag             |
| Jungle animals                                   |              |               | 1 bag             |
| Wooden farm animals                              |              | 1 box         | 2 boxes           |
| Medium (4") plastic cars                         |              | 6             | 6                 |
| Medium (4") plastic airplanes                    |              | 6             | 6                 |
| Medium mixed working vehicles                    |              |               | 12                |
| 10-12" metal or wood trucks                      |              | 1             | 3                 |
| 10-12" metal or wood airplanes                   |              | 1             | 3                 |
| Wooden snap or hook trains & tracks              |              |               | 1 set             |
| 8-10" wood or plastic boats                      |              | 1             | 2                 |
| <b>MANIPULATIVE TOYS &amp; TABLE ACTIVITIES:</b> |              |               |                   |
| Puzzles (3 to 6 pieces)                          |              | 6             |                   |
| Puzzles (6 to 20 pieces)                         |              |               | 12                |
| Puzzle rack                                      |              | 1             | 2                 |
| Large wooden beads                               |              | 2 sets        |                   |
| Turn-a-gear                                      |              | 1 set         | 2 sets            |
| Nesting blocks                                   |              | 1 set         | 2 sets            |
| Colored parquetry blocks                         |              | 2 sets        | 2 sets            |
| Dress-me-doll                                    |              | 2             | 3                 |
| Pounding benches                                 |              | 2             |                   |
| Play telephones                                  |              | 4             | 6                 |
| Picture matching cards                           |              | 4 sets        | 4 sets            |
| Lotto (farm, zoo, object, etc.)                  |              | 1 set         | 3 sets            |
| Anagrams   |              |               | 1 set             |
| Graduated number blocks                          |              |               | 1 set             |
| Hammer and nails                                 |              |               | 6 sets            |

- continued next page -



**INDOOR EQUIPMENT AND SUPPLIES**

| Item   | Quantity for   |                  |                      |
|--|----------------|------------------|----------------------|
|  | Infants<br>(5) | Toddlers<br>(10) | Preschoolers<br>(15) |
| <b>MANIPULATIVE TOYS &amp; TABLE ACTIVITIES (cont'd)</b> |                |                  |                      |
| Peg sets   |                | 2 sets           | 6 sets               |
| Constructor-straws                                       |                | 1 box            | 4 boxes              |
| Large set Tinker Toys                                    |                | 1                | 1                    |
| Large set Building Bricks                                |                |                  | 1                    |
| Large set Lego   |                |                  | 1                    |
| Build-a-City   |                |                  | 2                    |
| Lincoln Logs   |                |                  | 1 set                |
| Rubber Band Set  |                |                  | 4                    |
| Stacking blocks (graduated)                              |                |                  | 2                    |
| Black dominoes   |                |                  | 2 sets               |
| <b>SCIENCE MATERIALS:</b>                                |                |                  |                      |
| Magnifying glasses                                       |                |                  | 2                    |
| Color paddles  |                | 1 set            | 2 sets               |
| Magnets or magnistiks                                    |                | 2                | 4                    |
| Assortment planting seeds                                |                | x                | x                    |
| Planting area, or pots or flats                          |                | x                | x                    |
| Container for small bugs, lizards                        |                | 1                | 1 or 2               |
| Cooking spoon  |                | 1                | 2                    |
| Large plastic mixing bowl                                |                | 1                | 2                    |
| Egg beater   |                | 1                | 2                    |
| Rope, string, wheels                                     |                | x                | x                    |
| <b>ARTS AND CRAFTS:</b>                                  |                |                  |                      |
| (Consumables listed for 1 month)                         |                |                  |                      |
| Hexagonal kindergarten crayons                           |                | 5 boxes          | 8 boxes              |
| Boxed water colors and brushes                           |                |                  | 8 sets               |
| 25 lb. bags gray clay                                    |                | 1                | 2                    |
| #3/4 drafting pencils                                    |                |                  | 1 doz.               |
| Guitar oil pastels-24/box                                |                | 1 set            | 4 sets               |
| Mixed large chalks                                       |                | 1 box            | 2 boxes              |
| Mixed colored chalk                                      |                |                  | 1 box                |
| Large chalk board-min. 18" x 35"                         |                |                  | 1                    |
| Masonite clay boards - if tables inadequate              |                | 4                | 6                    |
| 12 color felt pens                                       |                |                  | 2 sets               |
| Library paste  |                | 3 jrs.           | 8 jrs.               |
| Wilhold glue   |                | 2 btls.          | 8 utls.              |
| Children's scissors                                      |                | 4 pr.            | 6 pr.                |
| Water Tempera Paints                                     |                |                  |                      |
| Red, yellow, blue  |                | 2 ea.            | 4 ea.                |
| White, green, orange, violet, black                      |                | 1 ea.            | 2 ea.                |
| Brown, magenta, amber, scarlet                           |                | 1 ea.            | 1 ea.                |
| <b>Brushes</b>   |                |                  |                      |
| 1" easel brushes   |                | 4                | 6                    |
| 3/4" easel brushes                                       |                | 4                | 8                    |

-continued-

**INDOOR EQUIPMENT AND SUPPLIES**

| Item                                    | Quantity<br>for |                  |                      |
|---|-----------------|------------------|----------------------|
|   | Infants<br>(5)  | Toddlers<br>(10) | Preschoolers<br>(15) |
| <b>ARTS AND CRAFTS - continued</b>      |                 |                  |                      |
| Brushes - continued                     |                 |                  |                      |
| 1/2" med. bristles - table paints       |                 | 4                | 8                    |
| 2" outdoor water-painting brushes       |                 | 4                | 8                    |
| Painting easel (double)                 |                 | 2                | 3                    |
| <b>PAPER</b>                            |                 |                  |                      |
| 12 x18 white construction               |                 |                  | 2 pkgs               |
| 12 x18 black construction               |                 |                  | 1 pkg                |
| 12 x 18 mixed construction              |                 |                  | 2 pkgs               |
| 9 x 12 white construction               |                 | 1 pkg            | 2 pkgs               |
| 9 x 12 black construction               |                 | 1 pkg            | 2 pkgs               |
| 9 x 12 red construction                 |                 | 1 pkg            | 1 pkg                |
| 9 x 12 yellow construction              |                 | 1 pkg            | 1 pkg                |
| 9 x 12 blue construction                |                 | 1 pkg            | 1 pkg                |
| 9 x 12 green construction               |                 | 1 pkg            | 1 pkg                |
| 9 x 12 mixed construction               |                 | 1 pkg            | 2 pkgs               |
| Sheets mixed colored tissue paper       |                 |                  | 24 shts.             |
| 18 x 24 - 100 sheets newsprint          |                 | 1 pkg            | 2 pkgs               |
| <b>HOUSEHOLD ITEMS FOR ART</b>          |                 |                  |                      |
| Food Coloring                           |                 | 1 pkg            | 1 pkg                |
| 1 Qt. bottles liquid laundry starch     |                 | 2                | 4                    |
| 25 lb. bag white flour                  |                 | 1                | 1                    |
| 10 lb. bag salt                         |                 | 1                | 1                    |
| 1 qt. cooking oil                       |                 | 1                | 1                    |
| Flour shakers                           |                 | 2                | 4                    |
| Plastic or terry cloth aprons           |                 | 4                | 6                    |
| Clothespins                             |                 | 1 doz.           | 1 doz.               |
| Clay-storage container                  |                 | 1                | 1                    |
| Dishpan for dough storage               |                 | 1                | 1                    |
| Pkg. tongue blades                      |                 | 1                | 1                    |
| Ball sturdy string                      |                 | 1                | 1                    |
| TV Dinner trays                         |                 | 4                | 6                    |
| Small cans or cut off milk cartons      |                 | 32               | 64                   |
| Sponges                                 |                 | 4                | 4                    |
| Cottage cheese or sour cream containers |                 | 1 doz            | 2 doz                |
| Hosiery boxes                           |                 | 1 doz            | 2 doz                |
| Adequate supply newspaper               |                 |                  |                      |
| Collage materials                       |                 |                  |                      |



**OUTDOOR EQUIPMENT & SUPPLIES**

| Item  | Quantity for |               |                   |
|---|--------------|---------------|-------------------|
|   | Infants (5)  | Toddlers (10) | Preschoolers (15) |
| <b>BASIC FURNITURE</b>                          |              |               |                   |
| Garden Umbrella                                 | 1            | 1             |                   |
| Umbrella base                                   | 1            | 1             |                   |
| Adult Chair                                     | 2            | 2             | 2                 |
| Outdoor low table<br>(finished for outdoor use) |              | 2             | 3                 |
| Outdoor chairs<br>(low to fit under table)      |              | 12            | 20                |
| <b>BLOCKS:</b>                                  |              |               |                   |
| Hollow 5 1/2 x 11 x 11                          |              |               | 24                |
| Hollow 5 1/2 x 11 x 22                          |              |               | 12                |
| Hollow 5 1/2 x 5 1/2 x 11                       |              |               | 12                |
| <b>LARGE MUSCLE EQUIPMENT:</b>                  |              |               |                   |
| Jungle gym or other climbing apparatus          |              | 1             | 1                 |
| Saw Horses                                      |              | 2             | 2                 |
| Metal or wooden fences with rungs               |              |               | 2                 |
| 8' flexible jumping boards with<br>end cleats   |              |               | 1                 |
| 4' flexible jumping boards with<br>end cleats   |              | 1             | 2                 |
| 6' cleated teeter-totter board                  |              |               | 1                 |
| Packing cases 42 x 30 x 30                      |              | 2             | 2                 |
| Ladders 4' rungs 8" apart with<br>end cleats    |              |               | 2                 |
| Swings with canvas seats                        |              | 2             | 2                 |
| Balls of varied sizes                           |              | 4             | 6                 |
| <b>OUTDOOR WHEEL EQUIPMENT:</b>                 |              |               |                   |
| Tricycles (12" wheel diameter)                  |              | 4             |                   |
| Tricycles - (16" to 20" wheel diameter)         |              |               | 8                 |
| Wheelbarrows                                    |              | 2             | 4                 |
| Small Wagon                                     |              | 1             | 2                 |
| Express Wagon                                   |              | 1             | 2                 |
| Go-Cart, Fire Engine, Airplane, etc.            |              | 1             | 2                 |
| Pull Toys                                       | 2            | 5             |                   |
| <b>SANDBOX AND WATER PLAY SUPPLIES:</b>         |              |               |                   |
| 12" manual sand shovels-sturdy                  |              | 6             | 8                 |
| 2 qt. plastic or metal pails                    | 2            | 6             | 8                 |
| Sugar scoops                                    |              | 6             | 8                 |
| Plastic bottles with wide openings              |              | 6             | 8                 |
| Measuring cups                                  | 2            | 6             | 8                 |
| Lengths of hose                                 | 1            | 1             | 1                 |

-continued-

**OUTDOOR EQUIPMENT & SUPPLIES**

| Item  | Quantity<br>for |                  |                      |
|---|-----------------|------------------|----------------------|
|   | Infants<br>(5)  | Toddlers<br>(10) | Preschoolers<br>(15) |
| <b>SANDBOX AND WATER PLAY SUPPLIES (cont'd)</b>                 |                 |                  |                      |
| Odds and ends -<br>plastic dishes, pots, pans,<br>mixing spoons |                 |                  |                      |
| Workable but used -<br>plastic or metal cars, trucks,<br>boats  |                 |                  |                      |
| Colanders, strainers  |                 |                  |                      |
| 4" plastic boats  | 2               | 6                | 1 doz.               |
| 6' x 8' shaded sand box   | 1               | 1                |                      |
| 8' x 12' shaded sand box  |                 |                  | 1                    |
| <b>WOODWORKING:</b>   |                 |                  |                      |
| Sturdy medium-sized claw hammers                                |                 | 2                | 4                    |
| Sturdy medium-sized saws  |                 |                  | 4                    |
| Box blue 1" nails   |                 |                  | 1                    |
| Box roofing nails   |                 | 1                | 1                    |
| Mixed sandpaper   |                 |                  | 1 pkg.               |
| Large carton mixed pieces:<br>soft pine and other scraps        |                 | 1                | 1                    |
| Workbench or adequate table area                                |                 | 1                | 1                    |
| Quality C-clamps  |                 | 2                | 4                    |
| <b>MISCELLANEOUS:</b>   |                 |                  |                      |
|   |                 |                  |                      |

**PARTIAL  
LIST OF RESOURCES FOR THE PURCHASE OF EQUIPMENT AND SUPPLIES**

AMERICAN SEATING CO.  
901 Broadway  
Grand Rapids, Mich. 49502

CHILDREN'S MUSIC CENTER  
5373 West Pico Blvd.  
Los Angeles 90019

COMMUNITY PLAYTHINGS  
Rifton, New York  
12471

CONSTRUCTIVE PLAYTHINGS  
1040 East 85th St.  
Kansas City, Mo. 64131

CHILDCRAFT EQUIPMENT CO., INC.  
155 East 23rd St.  
New York, N.Y. 10010

CREATIVE PLAYTHINGS  
P.O. Box 1100  
Princeton, New Jersey 08540

ED-U-CARDS MFG. CORP.  
60 Austin Blvd.  
Comack, New York 11725

FOLKWAYS RECORDS & SERVICE CORP.  
165 West 46th St.  
New York 10036

GEORGIA TENT AND AWNING CO.  
228 Margaret St., S.E.  
Atlanta, Georgia 30315

JUDY CO.  
310 N. 2nd St.  
Minneapolis, Minn. 55401

LEARNING CENTER, INC.  
Princeton, New Jersey 08540

LOS HERMANOS WORKSHOP  
4324 Woodberry St.  
Hyattsville, Maryland 20782

LYDON CRAFT EDUCATIONAL EQUIP.  
Box 12  
Rosemead, Calif. 91770

MONTGOMERY WARD  
(local outlet)

PLAYSKOOL MFG. CO.  
3720 N. Kedzie Ave.  
Chicago, Ill. 60618

SEARS ROEBUCK  
(local outlet)

SIFO CO.  
834 N. 7th St.  
Minneapolis, Minnesota 55411

TONKA TOYS INC.  
Mound, Minnesota 55364

TWO TIMES TWO  
1094 Hendersonville Road  
Asheville, N.C. 28803

WESTON WOODS STUDIOS  
Weston, Connecticut 06880

THE CUISENAIRE CO. of AMERICA, INC.  
12 Church St.  
New Rochelle, New York 10805

THE INSTRUCTO CORP.  
Paoli, Pennsylvania 19301

PLANS AND PATTERNS  
**FLOOR AND PLOT PLANS**

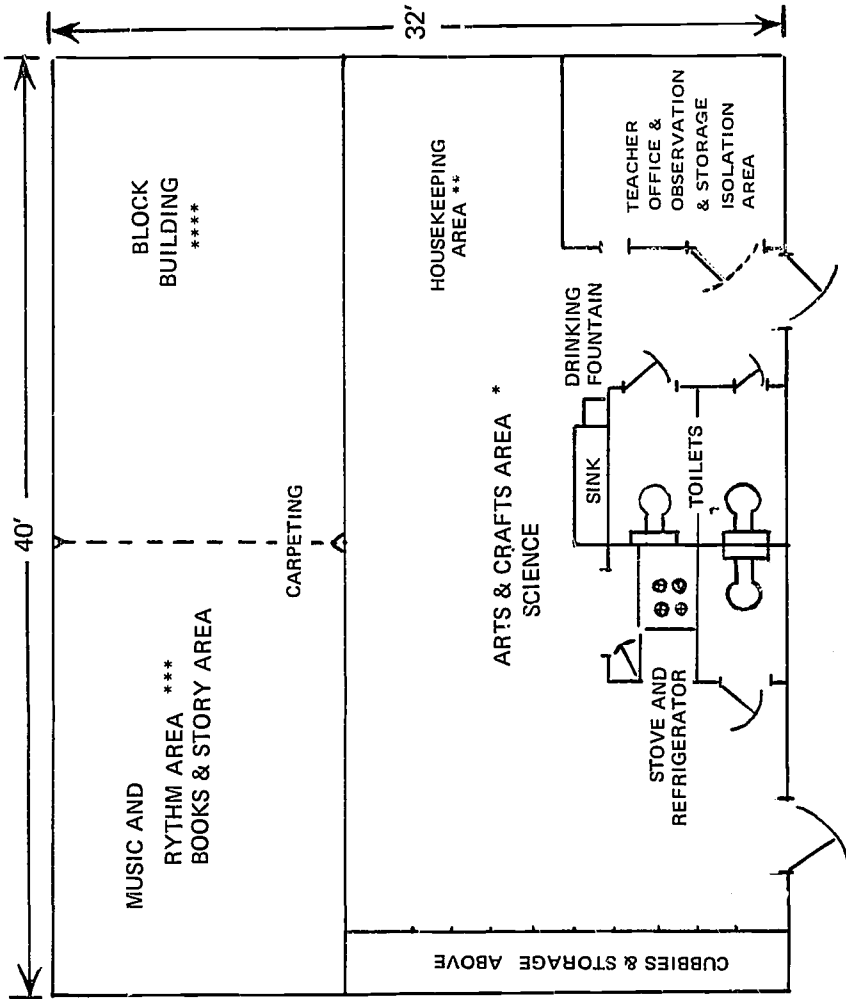

PORTABLE OR RELOCATABLE  
 CLASSROOM FOR 20 CHILDREN,  
 AGES 4-5 YEARS

\* SEE PAGES 49, 50  
 \*\*SEE PAGE 50  
 \*\*\*SEE PAGES 51, 52  
 \*\*\*\*SEE PAGE 51

# OUTDOOR PLOT PLAN

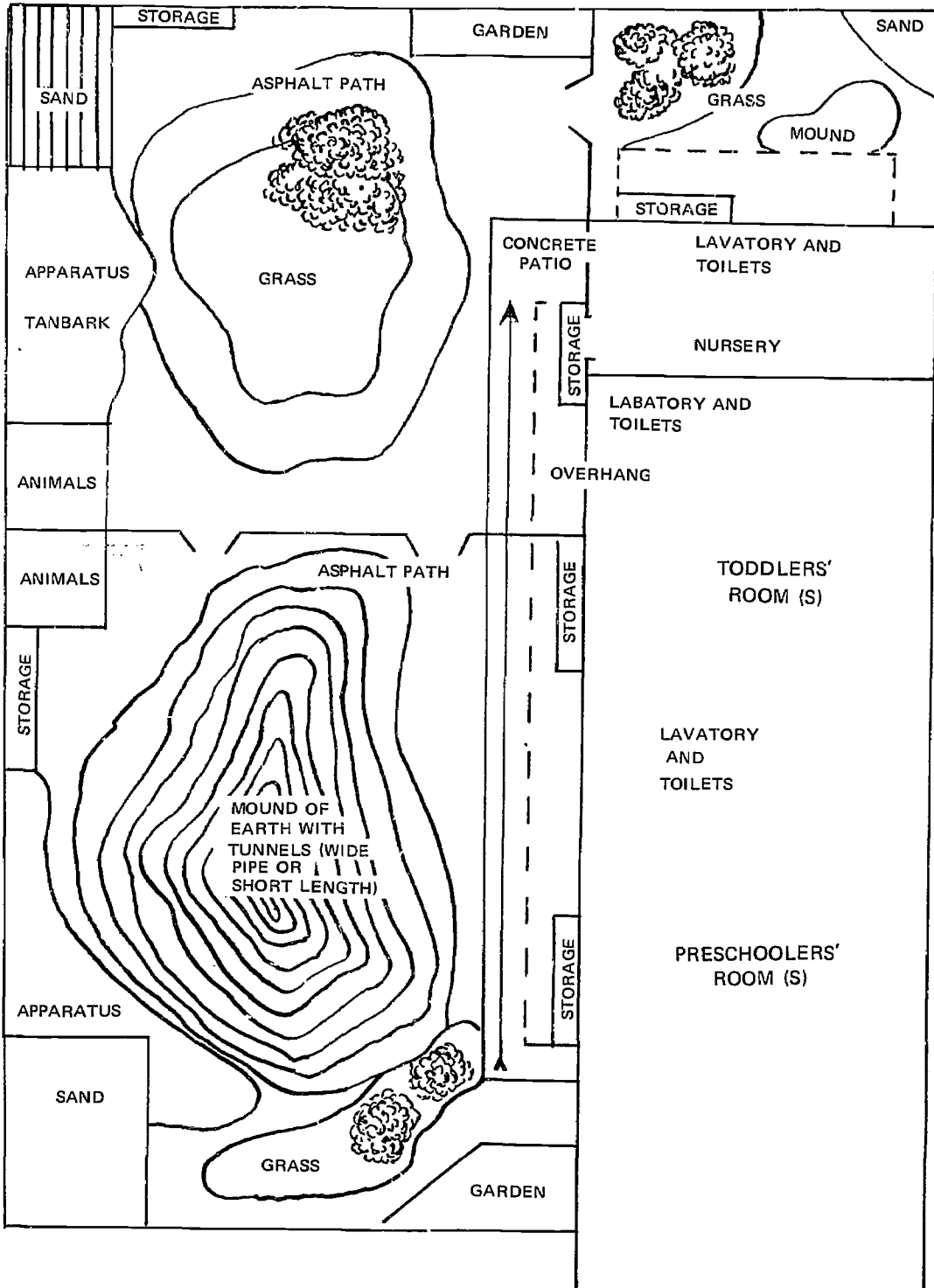



## FLOOR PLAN - CHILD DEVELOPMENT CENTER

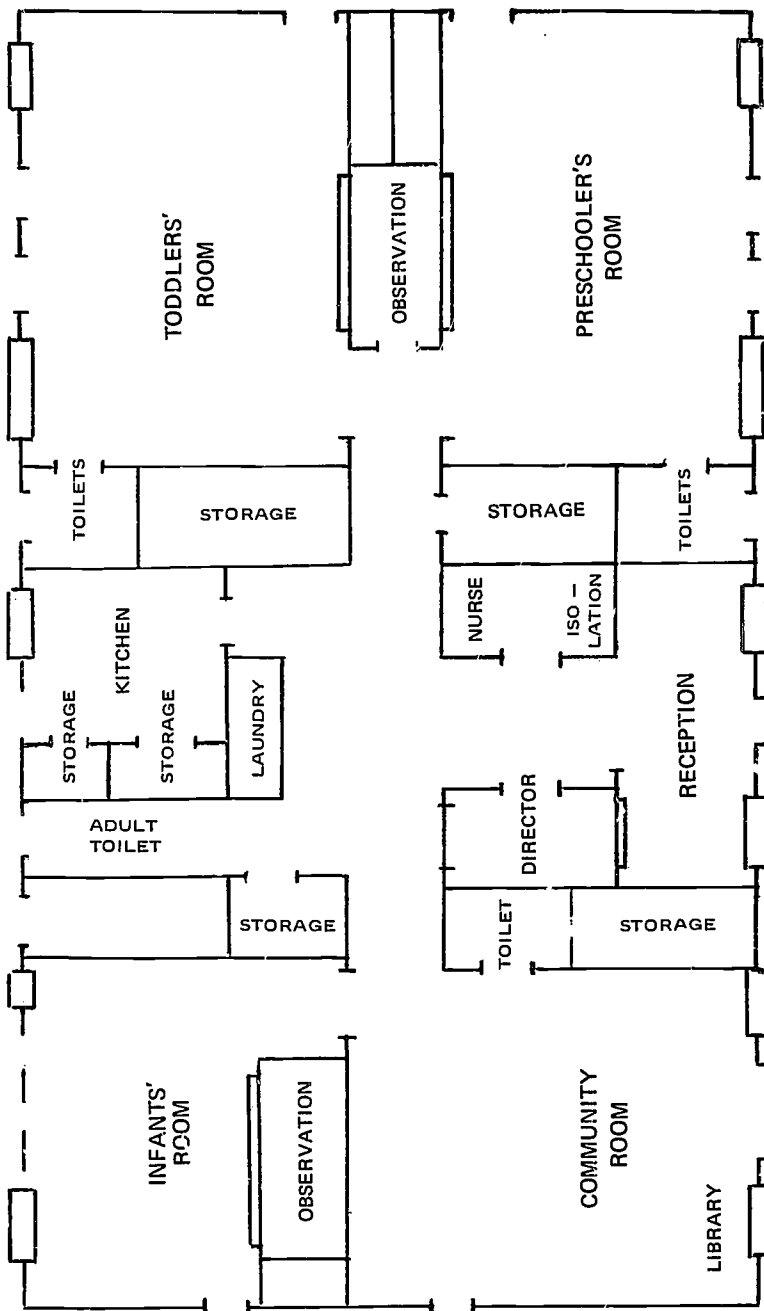

PATTERNS FOR CONSTRUCTION OF EQUIPMENT

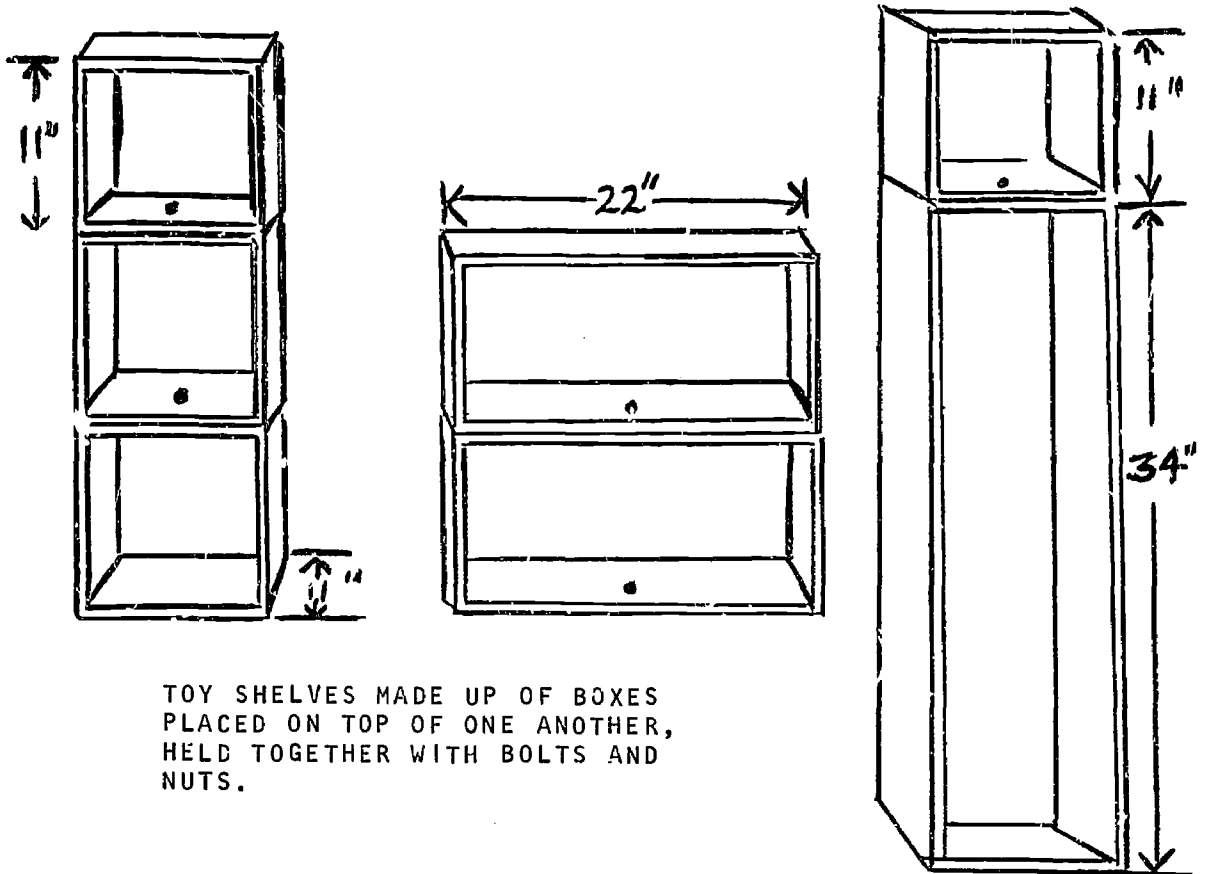

TOY SHELVES MADE UP OF BOXES  
PLACED ON TOP OF ONE ANOTHER,  
HELD TOGETHER WITH BOLTS AND  
NUTS.

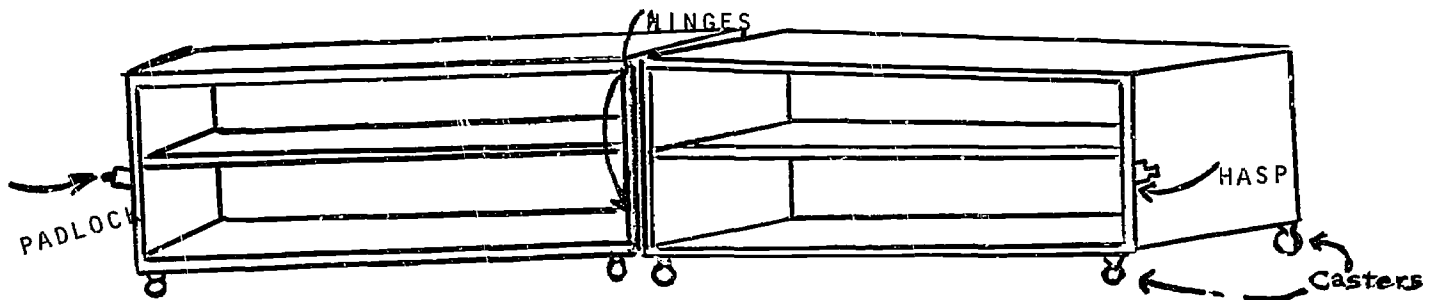

TWO TOP CUPBOARDS HINGED TOGETHER. TO CLOSE  
WHEN NOT IN USE, WHEEL ONE CUPBOARD AROUND  
IN FRONT OF THE OTHER AND PADLOCK IT AT THE  
END.

BOOKRACK AND TOYSHELVES

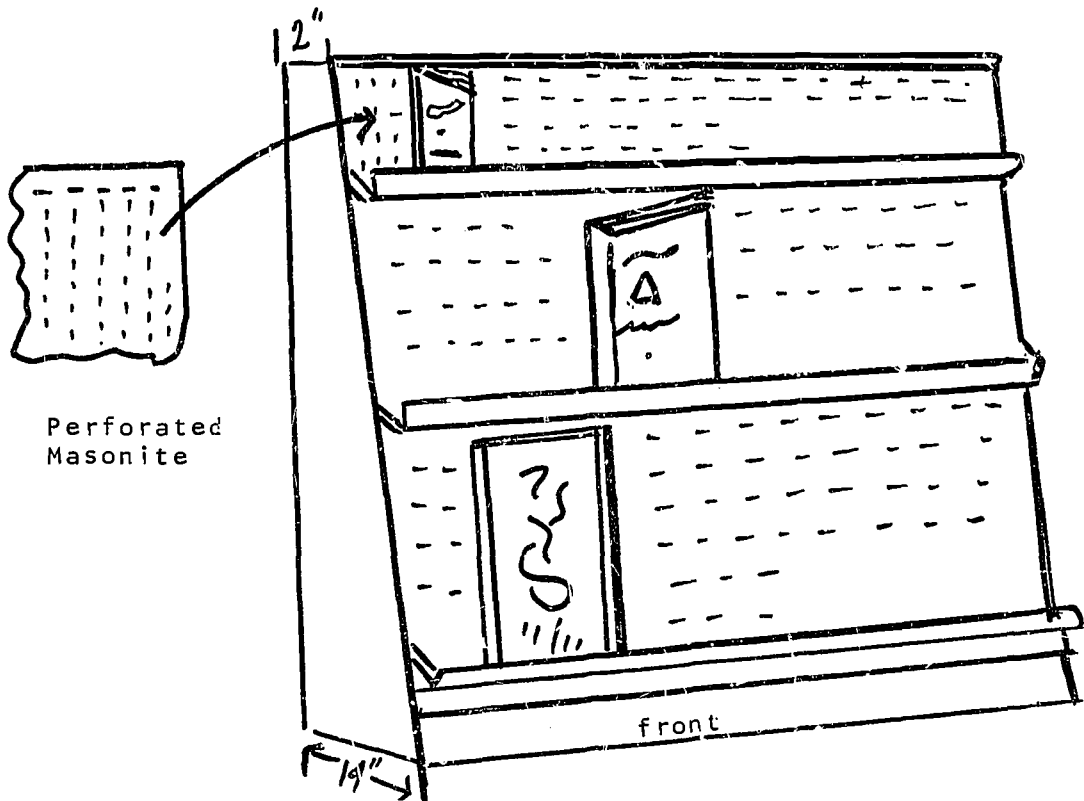

Perforated  
Masonite

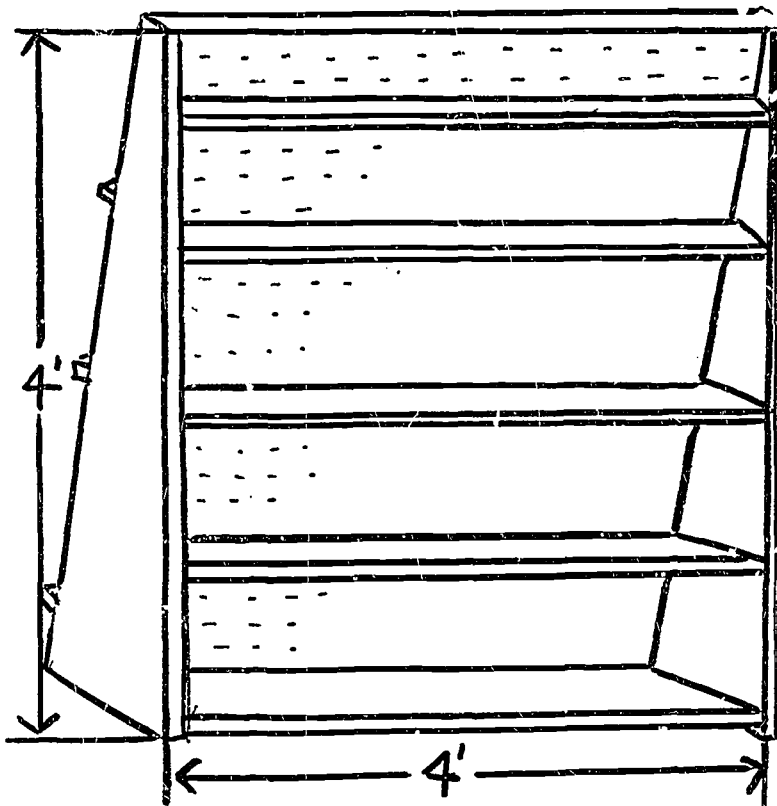

Back

5 shelves

Top shelf  
about 3" wide

Bottom shelf  
about 12" wide

BOOK DISPLAY

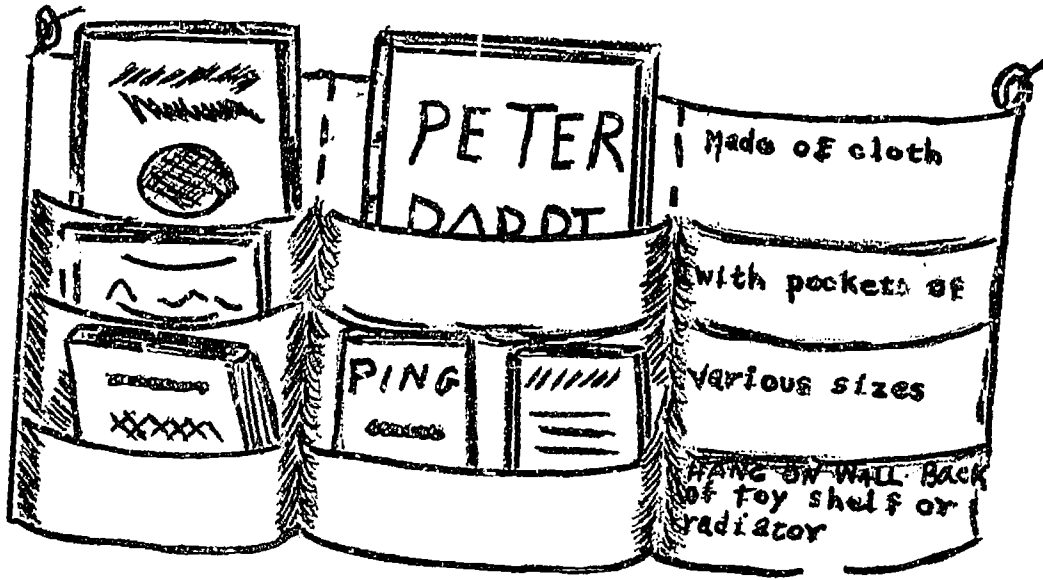

FOLDING BOOK RACK

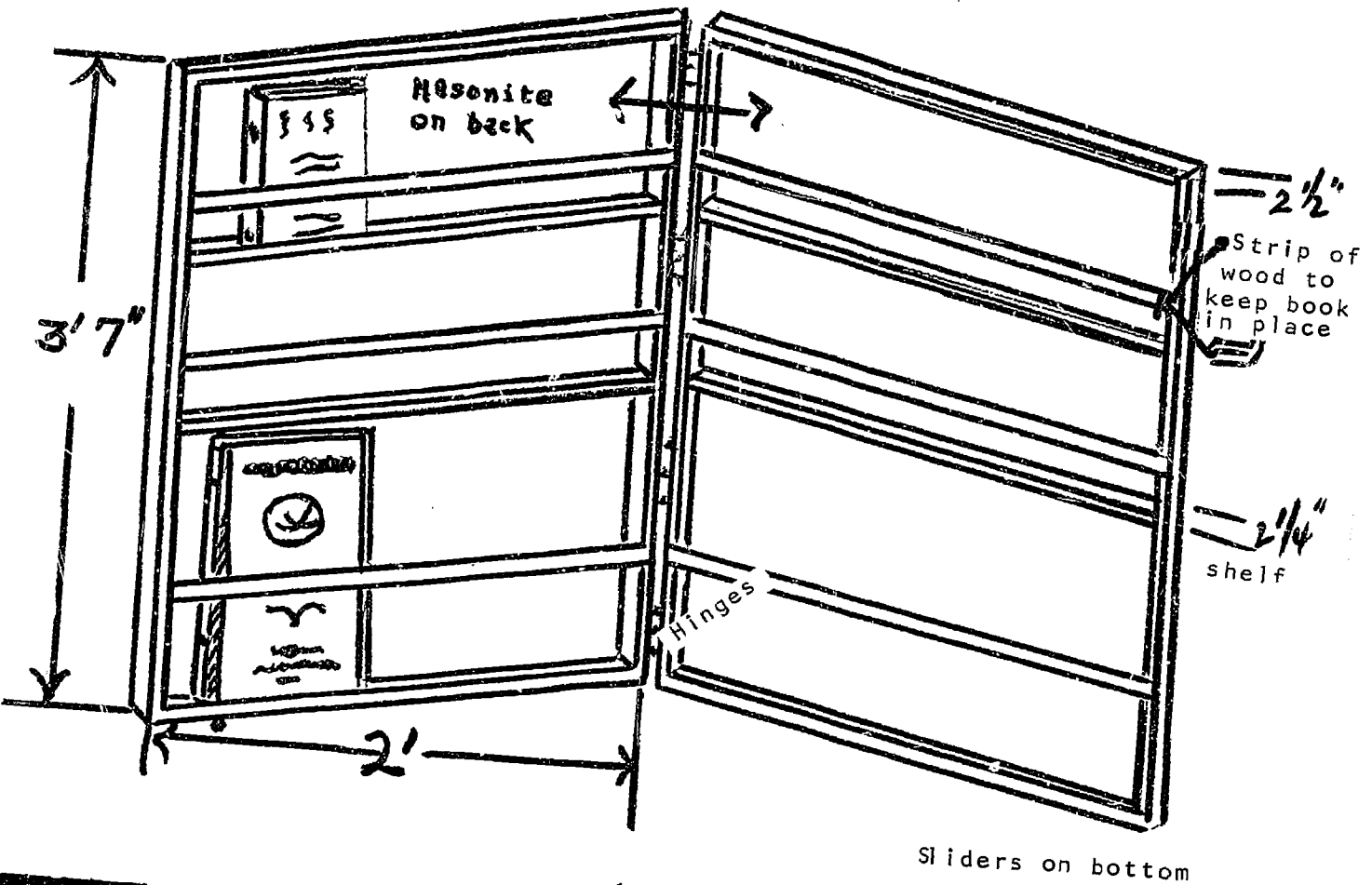

## CUBBIES

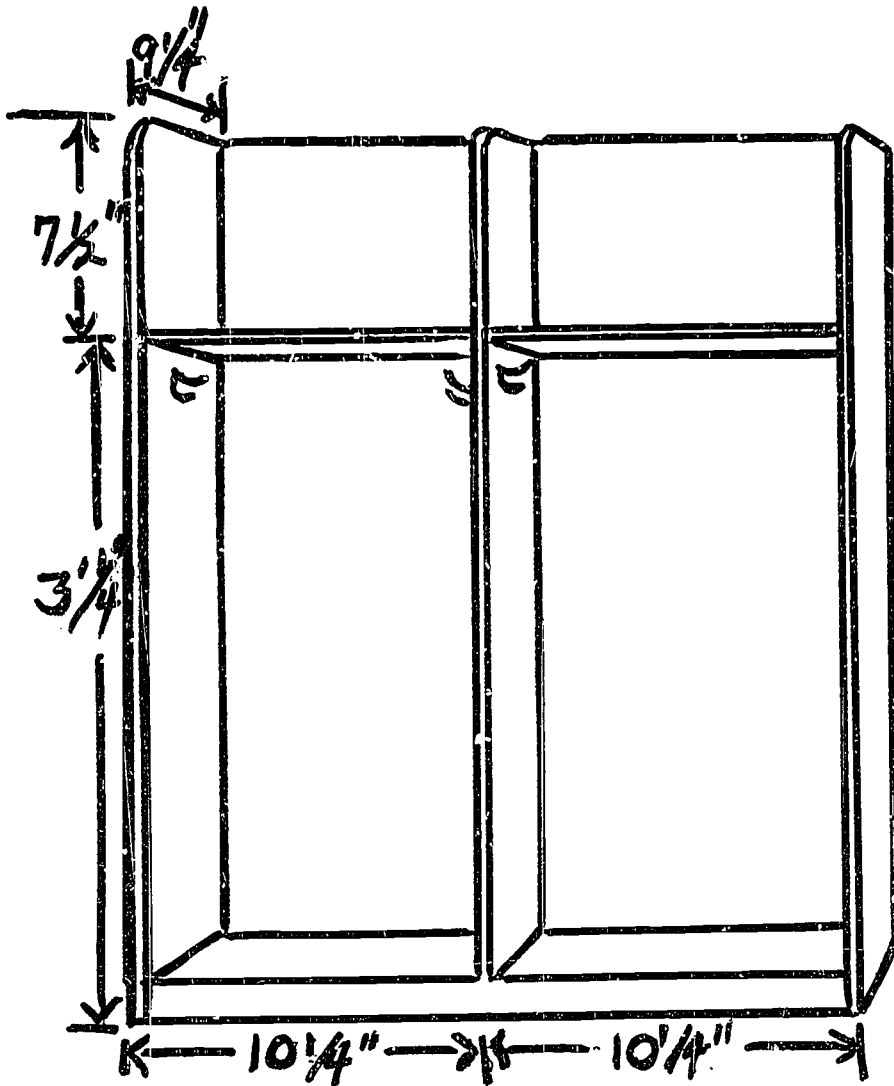

Coat cupboards can be made up in units of any number according to the space available. Five cupboards take up approximately 4 ft. 8 1/4 inches.

There are 2 hooks per cupboard.

For junior cupboards shorten the lower section to 2 ft. 2 1/2 inches.

MOVABLE COAT RACK - 6 hooks on each side

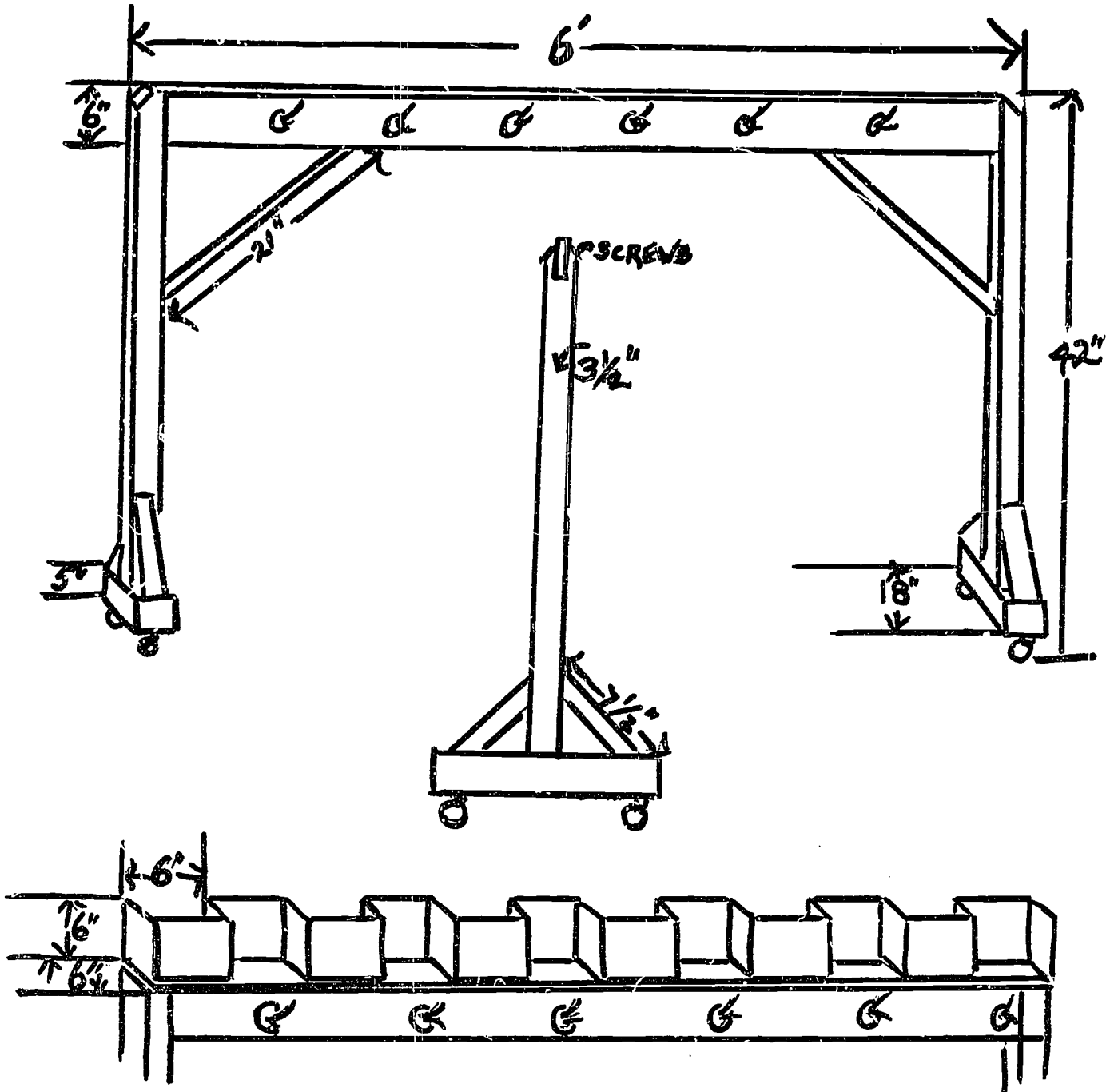

Cubicles for hats and mitts can be put on top of the clothes rack. A board 6" wide the length of the rack with plywood fastened on the board to form 6" square cubicles. Six hooks placed below the open cubicles on the front - 6 hooks on the back.

TOY AND STORAGE CUPBOARD

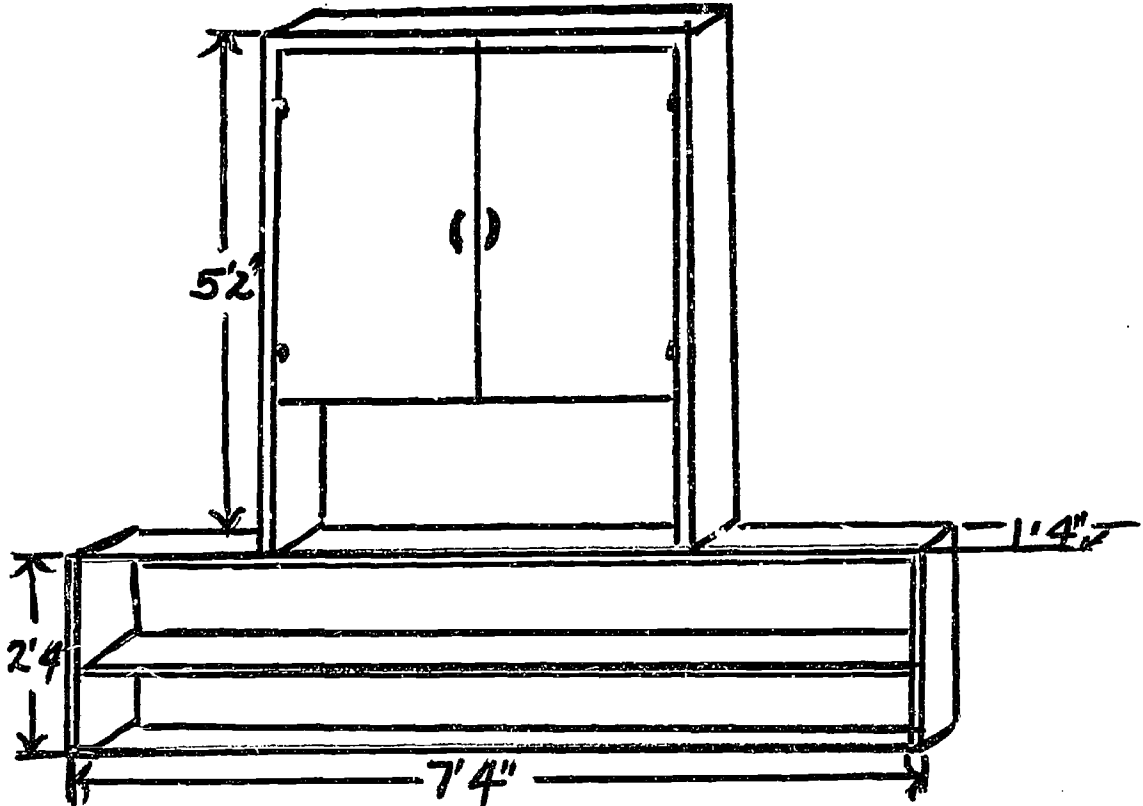

BLOCK CUPBOARD

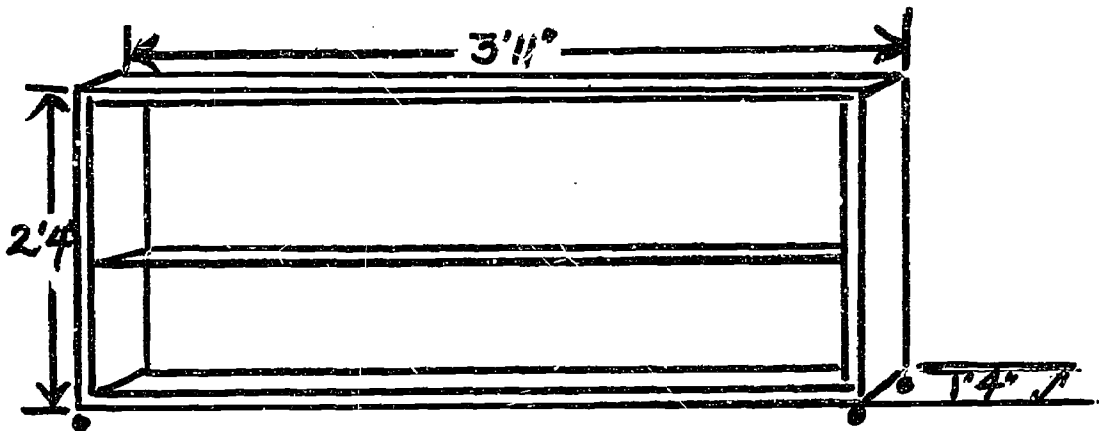

The suggested length of cupboard is a useful size but it can be varied to suit the location. Where possible fasten the storage cupboard on a wall and the toy cupboard mounted on casters.

If the toys have to be locked away make removable fronts to fit in slots at the bottom and locked at the top with a padlock.

## Bibliography

- Baker, Katherine Read, Let's Play Outdoors, (New York: National Association for the Education of Young Children, 1966).
- .....Bit and Pieces: Imaginative Uses for Children's Learnings (Washington, D.C.: Association for Childhood Education International, 1967).
- Dixon, Hanna, Hitch, John and Raper, Theresa, Parent Child Center (Raleigh, North Carolina: Community Development Group, School of Design, North Carolina State University)
- .....Equipment and Supplies, (Washington, D.C.: Association for Childhood Education International, 1968).
- Friedberg, M. Paul, Playgrounds for City Children (Washington, D.C.: Association for Childhood Education, International, 1969).
- Green, Marjorie and Woods, Elizabeth, A Nursery School Handbook for Teachers and Parents, (Sierra Madre, Calif: Sierra Madre Nursery School Association)
- Hamlin, R.H., Mukerji, Rose and Yonemura, Margaret, Schools for Young Disadvantaged Children, (New York: Teacher's College Press, Columbia University, 1967).
- Hasse, Ronald W., Designing the Child Development Center, (Washington, D.C.: U.S. Government Printing Office, 1968).
- Kretchevsky, Sybil Brand Prescott, Elizabeth and Walling, Lee, Planning Environments for Young Children - Physical Space, (Washington, D.C.: National Association for the Education of Young Children, 1969).
- Mallum, Mary Alice, California Children's Centers Curriculum Guide (Hawthorne, California: Calif. Children's Center, Directors and Supervisors Assoc., 1970).
- Mazyck, Aurelia, "Suggested Equipment and Supplies for Infant -- Toddler Center" -- mimeographed pamphlet printed by University of North Carolina at Greensboro, 1969.
- Nimnicht, Glen, McAfree, Oralie, and Meier, John, The New Nursery School, (New York: General Learning Corporation, 1969).
- .....Nursery School Portfolio, (Washington, D.C.: Association for Childhood Education International, 1968) -- price \$1.50 -- leaflet -- #15 -- "Places and Spaces" particularly pertinent
- .....Physical Education for Children's Healthful Living (Washington, D.C.: Association for Childhood Education, International, 1968).



Read, Katherine, The Nursery School, (Philadelphia: W.B. Saunders Co, 1960).

Stanton, Jessie and Rudolph, Marguerita, Planning a Nursery School Building, (New York: Bank Street College of Education, 1957) -- pamphlet #35.

Stanton, Jessie and Weisberg, Alma, Play Equipment for the Nursery School, (New York: Bank Street College of Education, 1962), pamphlet #70.

PHOTO AND ILLUSTRATION CREDITS:

Cover--Bob Warrick

Pages 8,9, 35, 37, and 41; 30 (#2), 31 (#1), 33 (#2), 40 (#2), 42 (#2 and #3)--Pacific Oaks Children's School--Pasadena, California.

Pages 6, 7, 11, 12, 13, 14, 15, 18, 20, 21, 22, 23, 24, 26, 27, 28, 32, 34, and 38; 30 (#1), 31 (#2 and #3), 33 (#1), 40 (#2), 42 (#1)--Santa Monica Children's Centers--Santa Monica, California.